

2022-07

Real time battery voltage level monitoring system for telecommunication towers a case study: Habari Node public limited company Arusha, Tanzania

Uwamahoro, Rahab

NM-AIST

<https://doi.org/10.58694/20.500.12479/1607>

Provided with love from The Nelson Mandela African Institution of Science and Technology

**REAL TIME BATTERY VOLTAGE LEVEL MONITORING SYSTEM
FOR TELECOMMUNICATION TOWERS A CASE STUDY: HABARI
NODE PUBLIC LIMITED COMPANY ARUSHA, TANZANIA**

Rahab Uwamahoro

**A Project Report Submitted in Partial Fulfilment of the Requirements for the Degree of
Master of Science in Embedded and Mobile System of the Nelson Mandela African
Institution of Science and Technology**

Arusha, Tanzania

July, 2022

ABSTRACT

Voltage fluctuations in batteries during consumption are amongst the challenges facing telecommunication towers. Due to these fluctuations, many injuries that cause deaths and environmental poisoning have been reported. These fluctuations and injuries mainly occur due to poor management and lack of battery voltage-level monitoring systems after installation. This paper proposes a battery voltage-level monitoring system to be used in telecommunication towers. The proposed solution is incorporated with a centralized mobile application dashboard that allows access to the live data of the installed battery due to integration with components for sensing the battery's voltage, current, and temperature levels, as well as fire, and gas contents. An Arduino Uno microcontroller board was used in the processing and analysis of the data collected from the sensors. The global service message module (GSM) internet connectivity was used to store and monitor data in the cloud. The user was then alerted about low voltage, detected fire, and increased levels of harmful gases in the tower through a short message service (SMS). The experiment was conducted at Ngorongoro and Manyara telecommunication towers and it revealed that the developed battery voltage-level monitoring system could access battery information remotely while allowing users to continually monitor the battery usage in telecommunication towers in real-time. The unique value of this study is the proposed battery voltage-level monitoring system that contributes to the elimination of battery hazards in telecommunication towers. The proposed battery voltage-level monitoring system can be adopted by telecommunication towers engineers to reduce voltage fluctuation risks like injuries, environmental degradation, and deaths.

DECLARATION

I, Rahab Uwamahoro do hereby declare to the Senate of the Nelson Mandela African Institution of Science and Technology that this Report is my own original work and that it has neither been submitted nor being concurrently submitted for a similar degree award in any other institution.

Rahab Uwamahoro

.....

.....15/07/2022.....

Name and Signature of the Candidate

Date

The above declaration is confirmed by

Dr. Neema Mduma

... ..

... ..15/07/2022....

Name and Signature of Supervisor 1

Date

Dr. Dina Machuve

.....

.....

Name and Signature of Supervisor 2

Date

COPYRIGHT

This dissertation is copyright material protected under the Berne Convention, the Copyright Act of 1999, and other international and national enactments, on that behalf, on intellectual property. It must not be reproduced by any means, in full or in part, except for short extracts in fair dealing; for researcher private duty, critical scholarly review or discourse with an acknowledgment, without the written permission of the office of Deputy Vice-Chancellor for Academic, Research, and Innovation on behalf of both the author and the Nelson Mandela African Institution of Science and Technology.

CERTIFICATION

The undersigned certify that, they have read and found a project report titled, “*A battery voltage level monitoring system for telecommunication towers a case study: Habari node public limited company Arusha, Tanzania*” qualify for acceptance by the Nelson Mandela African Institution of Science and Technology (NM-AIST) in Arusha, in partial fulfillment of the requirements for the degree of Master of Science in Embedded and Mobile Systems of the Nelson Mandela African Institution of Science and Technology.

Dr. Neema Mduma



.....

.....15/07/2022.....

Name and Signature of Supervisor 1

Date

Dr. Dina Machuve

.....

.....

Name and Signature of Supervisor 2

Date

ACKNOWLEDGEMENTS

First of all, I am grateful to God the Almighty for enabling me to be part of the Nelson Mandela African Institution of Science and Technology (NM-AIST) and providing me with determination and strength during my masters' studies.

I acknowledge and thank the continued support from the Center of Excellence for ICT in East African (CENIT@EA) for financing my studies for 2 years.

I express my gratitude to my supervisors; Dr. Neema Mduma and Dr. Dina Machuve, for providing great support, advice, and mentorship. I also extend my appreciation to Dr. Elizabeth Mkoba for her constructive comments and encouragement during the preparation of my manuscript.

I owe my gratitude to my industrial supervisors; Mr. Lomayani Solomon from HABARI NODE Public Limited Company in Arusha, and Mr. Judah A. Robert, the Chief Technical Officer of the Automatenics Technologies Company in Nigeria for their contribution, support, and cooperation.

I am also indebted to recognize the role played by my family, keeping in mind their assistance which helped me to achieve my goals

DEDICATION

I dedicate my project work to my father, Benjamin Nsekanabo, for his motivation and love with my late Mother, Esperance Nyirambabajende.

TABLE OF CONTENTS

ABSTRACT.....	i
DECLARATION	ii
COPYRIGHT.....	iii
CERTIFICATION	iv
ACKNOWLEDGEMENTS.....	v
DEDICATION.....	vi
TABLE OF CONTENTS.....	vii
LIST OF TABLES	xi
LIST OF FIGURES	xii
LIST OF ABBREVIATIONS AND SYMBOLS	xv
CHAPTER ONE.....	1
INTRODUCTION	1
1.1 Background of the problem.....	1
1.2 Statement of the problem	3
1.3 Rationale of the study.....	4
1.4 Research Objectives	4
1.4.1 General objective	4
1.4.2 Specific objectives	4

1.5	Research Questions	4
1.6	Significance of the study	5
1.7	Delineation of the study	5
CHAPTER TWO		6
LITERATU REREVIEW		6
2.1	Introduction	6
2.2	Evolution History of Batteries.....	6
2.2.1	Non-rechargeable batteries (Primary cells).....	7
2.2.2	Rechargeable batteries (Secondary Cells).....	7
2.2.3	Evolution of Renewable energy status in Africa.....	8
2.3	Monitoring renewable energy	10
2.4	Related works	11
CHAPTER THREE		15
MATERIALS AND METHODS.....		15
3.1	Introduction	15
3.2	Area of study	15
3.3	Research Methods	16
3.4	Target Population and Sample Size	16
3.5	Sampling Techniques	16

3.6	Data collection methods	16
3.6.1	Primary data	16
3.6.2	Secondary data	18
3.7	Data analysis	18
3.8	System Development Approach.....	18
3.8.1	XP Agile method	18
3.8.2	System Analysis	19
3.8.3	System Design.....	22
3.8.4	System Development.....	24
3.8.5	System Validation	33
CHAPTER FOUR.....		34
RESULTS AND DISCUSSION.....		34
4.1	Results	34
4.2	Dashboard Data Results	36
4.3	Discussion	39
CHAPTER FIVE		40
CONCLUSION AND RECOMMENDATIONS		40
5.1	Conclusion.....	40
5.2	Recommendations	40

REFERENCES 42

APPENDICES 52

LIST OF TABLES

Table 1: Tower location coordinate	15
Table 2: Manual measurement results	17
Table 3: System testing summary	31
Table 4: Results from the developed system	34
Table 5: Existing system comparison with Developed system.....	38

LIST OF FIGURES

Figure 1: Battery (Arndt, 1932)	7
Figure 2: Price reduction of electrical battery on the market 2010 -2030 (Stevens, 2019).	8
Figure 3: Population without access to electricity in Africa 2000 -2020 (Statista, 2020).....	9
Figure 4: Electricity in the 20 least-electrified countries, 2010-19 (World Bank, 2020)	9
Figure 5: Renewable energy capacity investment 2010-2019 (Scharich et al., 2017).....	11
Figure 6: Digital Multimeter with batteries.	17
Figure 7: Extreme Programming diagram	19
Figure 8: Hardware testing in proteus software	20
Figure 9: Voltage divider	22
Figure 10: System hardware components integration.....	23
Figure 11: System Flowchart	24
Figure 12: Mobile dashboard interface	25
Figure 13: Arduino Uno.....	26
Figure 14: Relay.....	27
Figure 15: Buck converter	27
Figure 16: Voltage sensor	28
Figure 17: Current sensor.....	28
Figure 18: GSM Module.....	29

Figure 19: Flame sensor	29
Figure 20: Gas sensor MQ-3.....	30
Figure 21: DHT 11 sensor.....	30
Figure 22: Lab testing stage.....	32
Figure 23: Field testing stage.....	32
Figure 24: Batteries used with a multimeter and developed system used in testing.....	35
Figure 25: Final prototype for both towers	36
Figure 26: Mobile application for the system and sensed data on the dashboard.....	37
Figure 27: Dashboard and SMS notification sent by GSM (Ngorongoro)	37

LIST OF APPENDICES

Appendix 1: Interview guide	52
Appendix 2: Sample questions for user qcceptance validation	55
Appendix 3: User testing	56
Appendix 4: Prototype development stage	57
Appendix 5: Program source code for NGORONGORO Tower	57
Appendix 6: Program source code for MANYARA Tower	62
Appendix 7: Program source code for Mobile dashboard (Rahab power Manager)	66
Appendix 8: Research output.....	78

LIST OF ABBREVIATIONS AND SYMBOLS

AC	Alternating Current
ADC	Analogue to Digital Converter
CNBC	Consumer News and Business Channel
CNN	Convolutional Neural Network
DC	Direct current
GHG	Greenhouse Gas
GPRS	General Packet Radio Service
GSM	Global System for Mobile
ICT	Information and Communication Technology
IDE	Integrated Development Environment
IoT	Internet of Things
ISP	Internet Service Provider
LAT	Latitude
LCD	Liquid Crystal Display
LED	Light-Emitting Diodes
Li_2CO_3	Lithium Cobalt Oxide
LONG	Longitude
LSTM	Long Short-Term Memory

NASA	National Aeronautics and Space Administration
NM	Nanometer
OS	Android Operating System
PLC	Public Limited Company
Rx	Receiver
SD	Secure Digital
SDG	Sustainable Development Goal
SMS	Short Message Service
TCP/IP	Transport Control Protocol/Internet Protocol
Tx	Transmitter
UPF	Unscented Particle Filter
XP	Extreme Programming
PC	Personal Computer
V	Voltage
%	Percentage

CHAPTER ONE

INTRODUCTION

1.1 Background of the Problem

The rapidly growing population, technological advancement, and climate change have raised the demand for energy (Bhanutej & Naidu, 2021), which is expected to increase Greenhouse Gas (GHG) emissions in the atmosphere. The global population, for instance, is expected to grow from 7.7 to 9 billion by 2050 (UN, 2019), whereas, in Sub-Saharan Africa, where Tanzania is located, the population is predicted to double by 2050 (Economist, 2020). About 80% of the 1.4 billion of the global population in the rural areas have inadequate access to electricity (Kaygusuz, 2012). This means that a significant portion of the population in Sub-Saharan Africa lacks adequate energy to power their houses and electronic devices (The World Bank, 2021). These people have a low quality of life and lack access to technology, which means that they fall into the energy poverty deception category. The instability of national grids and the low proportion of the population accessing them due to their high costs make renewable energy a priority mechanism of electrification, especially in Africa. It is low-cost, user-friendly, and can reduce carbon footprint (Odarno *et al.*, 2017).

The Telecom Tower Company in Tanzania has found significant reliable use of renewable energy like solar panels that keep their services available without power outages and enable cost-efficient evolution to a low-carbon power system (Kaur *et al.*, 2020). The advancement of solar energy presented has increased in Tanzania (Takouleu, 2020). However, solar energy offers efficient production only during the day, which necessitates energy storage in batteries for future use or continuation of services when the national grid fails to operate (Chakrabarti *et al.*, 2013; Q. Li *et al.*, 2017; Lucien *et al.*, 2021; Yi *et al.*, 2018). Telecom Towers connect people with their businesses remotely by accessing the internet and other services. Powering the towers requires a stable source of power or energy for versatile operation. To guarantee their uninterrupted operation, the towers need to depend on renewable energy like solar panels to eliminate the inconveniences caused by unpredictable power cuts on the national grid (Dalela *et al.*, 2014).

The most severe challenge encountered by Telecom Towers is the periodical and unexpected voltage decrease of batteries followed by cutoffs that happen without alerting users to act accordingly. This makes the tower services unavailable, thus lowering productivity while putting sensitive electrical equipment at risk. Additionally, the hydrogen gases from batteries during their consumption affect human health and the environment (Gao *et al.*, 2019; Lattanzio & Clark, 2020; Nedjalkov *et al.*, 2016). With this, there is need to monitor and eliminate battery voltage level changes and other parameters that may threaten human health.

Among the factors that have been identified as primary contributors to voltage fluctuations is the lack of data visualization by the user on where the battery is installed and the large number of devices allocated to be powered by a battery (Sugihara *et al.*, 2012). This causes a lack of information on when the voltage battery is expected to be low for timely actions. With technological advancements through the Internet of Things (IoT), remote access to data has become a routine for many companies and individuals. IoT with a dashboard has proved helpful in receiving, controlling, and accessing data remotely for appropriate actions. The technology is also user-friendly and benefits real-time data access (Azemi & Wahid, 2021; Rawat & Arjariya, 2015). Taking advantage of this technological advancement, some studies have been carried out to review, analyze, monitor, and compute data for real-time sensing in different areas (Wortmann & Flüchter, 2015). However, most of the previously conducted studies have only concentrated on monitoring single geographical areas and excluded monitoring batteries installed in towers. Furthermore, other studies have focused on monitoring batteries installed only in electric vehicles.

Sustainable Development Goal (SDG) number 7 is to have access to modern, affordable, clean, and reliable energy for all by 2030 (Daly, 2018). However, previous research has failed to contribute to the accomplishment of this goal. Attention needs to be drawn to having a cost-effective and user-friendly battery voltage-level monitoring system. This will contribute to real-time access of information about faults in batteries and consumption through a dashboard for the sustainability of usage.

1.2 Statement of the Problem

Battery users face challenges of power outages. This problem always happens without user alerts about when the voltage level is expected to be low for them to act accordingly by either swapping it or recharging it and other necessary information that can be used in risky situations. Power outages tend to cause data loss in companies and other places where batteries are installed, loss of time in physical visits, risks of damage to the powered electrical equipment, and environmental harms.

Habari Node Public Limited Company is one of the internet providers companies in Tanzania. It provides more than one service to its customers, including internet connectivity in Arusha and other regions. The company has a vision statement to be an Information and Communication Technology (ICT) company of choice in providing quality, affordable, cutting edge internet and ICT services in the country (CEMEX, 2019). The company started installing solar panels and storing energy through batteries to towers that provide internet in different regions to reduce carbon emissions from fossil fuels. In Arusha, the company has more than 20 towers.

Currently, the company is facing the challenge of voltage fluctuations of batteries installed at Ngorongoro and Manyara towers. Scripts email for towers with solar panels is currently being used to know when the battery of a particular tower is expected to be low or cause a power outage. However, this method is not efficient due to the inaccuracy of data time response. The company is also manually estimating when a battery can shut down to visit a specific tower with a multimeter (for measuring the remaining voltage manually) so that they swap it for the continuation of services. However, it has proven costly for the company to visit a site several times, which sometimes causes unavailability of tower services when the team fails to check their emails or to visit the site on time due to lack of a centralized system where data from batteries around their towers can be shared for accurate monitoring. The proposed low-cost, effective, and efficient battery voltage level monitoring system will contribute to the elimination of this challenge in the towers powered by batteries, allowing users to remotely access information on the installed battery in real-time and promote the sustainable usage of batteries.

1.3 Rationale of the Study

Batteries present many hazards where installed. Preventing physical damage, handling degradation, monitoring voltage levels, and other parameters that can be risky to the environment and people, hence the necessity to ensure safe operation and reliability (Hannan *et al.*, 2017). The proposed battery voltage-level monitoring system will allow the company to access real-time information of the batteries installed in towers, monitor the voltage, current, and temperature levels, as well as the gas content, and fire through a centralized dashboard interface that receives notifications and alert the company during critical usage situations.

1.4 Research objectives

1.4.1 General Objective

The main objective of this project was to develop a battery voltage-level monitoring system in towers for the Habari Node Limited Company using a mobile dashboard for real-time access to batteries voltage level information.

1.4.2 Specific Objectives

The project included the following specific objectives:

- i) To identify the requirements for developing battery voltage-level monitoring in towers through a dashboard.
- ii) To design and develop a system for real-time battery voltage-level monitoring in towers with a mobile dashboard application.
- iii) To validate the developed system in the selected towers of the Habari Node Limited Company.

1.5 Research Questions

- i) What are the requirements for developing a real-time battery voltage-level monitoring system?
- ii) How is a system for real-time monitoring battery voltage-level in towers through a mobile dashboard application designed and developed?

- iii) How valid is the developed system in the selected towers of the Habari Node Limited Company?

1.6 Significance of the Study

The developed low-cost battery voltage-level monitoring system in the towers will improve company productivity since the time taken to visit towers will be reduced, and the risks of voltage fluctuations will be eliminated. The lack of data visualization where batteries are installed proved to be the challenge facing battery users after installation. Regarding this challenge, this project developed a system that will allow the users to monitor battery voltage in real-time by receiving live data remotely through a mobile dashboard, alerting users on the expected low voltage of batteries and other parameters such as current from loads, and detecting fire and increased levels of harmful gases where the battery is installed. Therefore, the study is expected to promote the sustainable usage of batteries by eliminating battery voltage fluctuation risks.

1.7 Delineation of the Study

Monitoring renewable energy is a broad field. This work is not intended to cover the entire domain of renewable energy monitoring. The project focuses on monitoring real-time access to information about the consumption of batteries' voltage installed at Habari Node Limited Company. Some parameters such as theft of batteries in the towers were not covered in this project.

CHAPTER TWO

LITERATURE REVIEW

2.1 Introduction

This literature review seeks to clarify the different approaches covered in identifying the required method to adopt for the successful development of proposed systems. The chapter begins by describing the evolutionary history of batteries with their classification, evolution of renewable energy status in Tanzania, and monitoring renewable energy. Finally, the chapter looks at previous works done by other researchers on monitoring battery voltage by identifying their limitations to identify the research gaps.

2.2 Evolution History of Batteries

In the 1800s, the first electrical battery was introduced to the world by Alessandro Volta, who was an Italian physicist. This invention provided a continuous current which made the information and power portable (Britannica, 2021; Gitleman, 2014). The invention was applicable by applying layers of copper and zinc divided by layers of cardboard. The battery invented by Volta offered a short life power per hour as the current reduced and loss of power happened quickly. It also presented other limitations like leakage of electrolytes, causing short circuits, and increased internal resistance from hydrogen bubbles on the copper (Bobby, 2014). These drawbacks brought to the attention of different inventors that further advancements were required to upgrade the cell for continuous current operation. This made John Frederic Daniell come up with the Daniel cell in the 1820s. This was the first battery to be integrated with mercury and produced 1.1volts to eliminate the hydrogen bubbles on copper using the second electrolyte solution produced by the first one. This invention, however, met some limitations too. The Daniell cell could allow earthenware vessel ions to pass, thus prevented its mixing solution (Jayson, 2014).

Further advancements continued in attempts to eliminate the drawbacks of the previous batteries known as primary cells which were not rechargeable by developing secondary batteries that were rechargeable. Therefore, batteries can be classified into 2 different types as rechargeable and non-rechargeable.

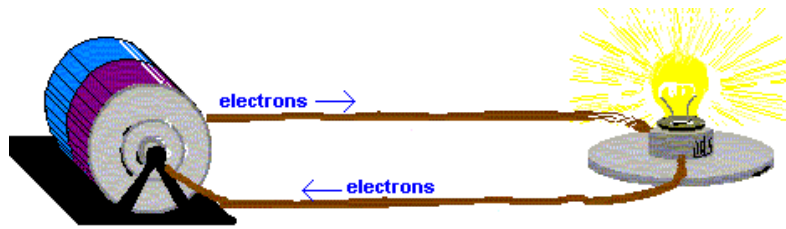

Figure 1: Battery (Arndt, 1932)

Both types consist of two electrodes, the anode, and the cathode, separated by the electrolyte, as shown in Fig. 1 (Goodenough, 2011). They generate electric currents that can power electronic devices when electrons are flowing (Arndt, 1932).

2.2.1 Non-rechargeable Batteries (Primary cells)

Non-rechargeable batteries, which are classified as single-use batteries that are discarded after use because the material inside changes irreversibly during discharge. These batteries are commonly known as dry cells which makes them alkaline, with more energy storage and low leakage of electrolytes (Flowers, 2020). They were introduced into the market in the 1960s, and present high voltage, low discharge rate, and density energies with negative electrodes and non-aqueous electrolytes.

2.2.2 Rechargeable Batteries (Secondary Cells)

Due to the limitations of single-use batteries or primary cells, much effort was put into developing rechargeable batteries known as secondary cells, which could be recharged when the voltage decreased (Salkind & Brodd, 1987). In 1859s, Gaston Plante introduced the lead-acid batteries which were rechargeable, supplying energy and powering devices for a long time (Magnet academy, 2014). From 1912 to 1991s, improvements in rechargeable batteries continued and Gilbert Newton (Asahi Chemical, Japan), started experimenting on lithium-ion batteries which are popular to date because of their efficiency in eliminating overheating and use in most electronic devices ranging from small ones to electrical cars (Blanchard, 2019).

The most advanced secondary batteries in the market are lithium batteries which have excessive amounts of Lithium cobalt oxide (Li_2CO_3) and Li/Co in more than unity, in raw materials. Sony

company was the first company to advance these batteries in the market for powering personal computers (PC), cellular phones, and other portable electronic devices (Nishi, 2001). Their unique features like affordability, efficiency, durability, and safety have made them advance in the market (Mcbreen, 1981). Their efficiency in storing energy and presenting uninterrupted power even when solar or wind power is used also made them advance quickly, especially in transportation when vehicles shifted from engine to electrical battery in the elimination of greenhouse gas emission and fossil-fuel-free transportation. In the wake of environmental protection from human activities like electricity generation and transportation, clean technology makes lithium secondary batteries popular in transportation, stationary, telecom, and offices due to the storage of large amounts of energy to ensure stable electricity flow (Hiroshi Kawamura, Marcelo LaFleur, Kenneth Iversen, 2020).

According to the Consumer News and Business Channel (CNBC), the demand and usage of electrical batteries will increase with costs estimated to drop below \$100/kWh by 2024 (Stevens, 2019) as presented in Fig. 2.

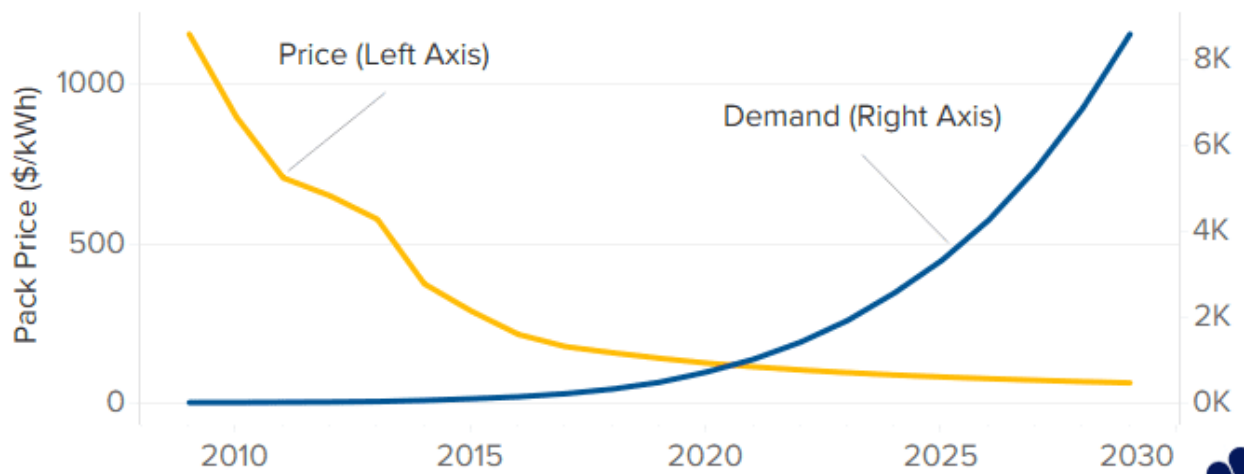

Figure 2: Price reduction of electrical battery on the market 2010 -2030 (Stevens, 2019).

2.2.3 Evolution of Renewable Energy Status in Africa

Africa has 1.2 billion of its population living in rural areas, with low electricity access as shown in Fig. 3 (Holtzkamp, 2018). Renewable energy proves to be a good solution in increasing electricity access in the region.

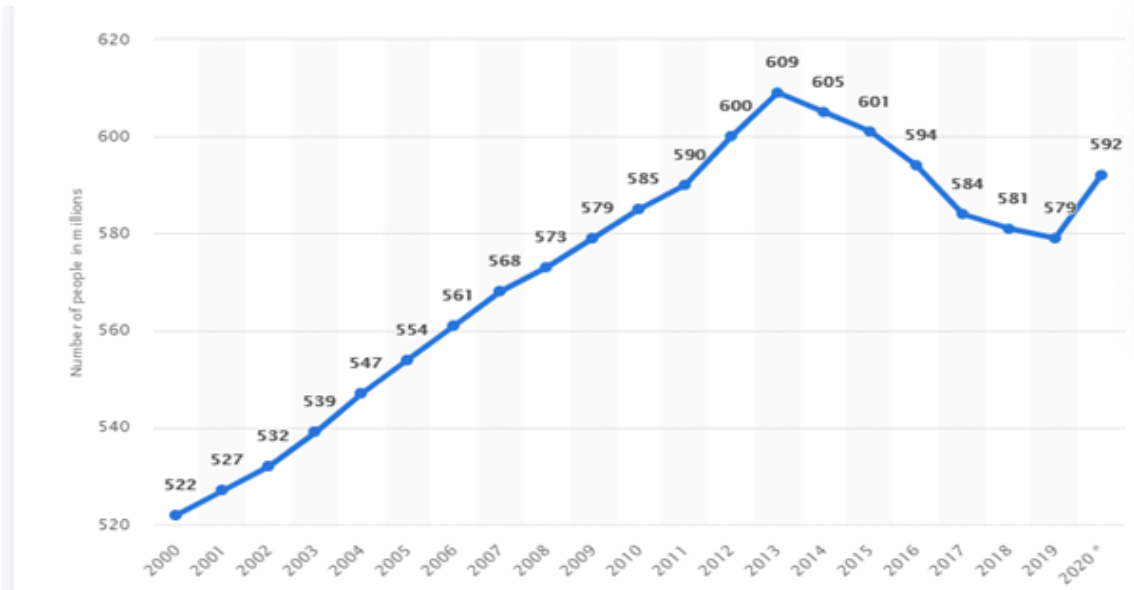

Figure 3: Population without access to electricity in Africa 2000 -2020 (Statista, 2020)

African countries are making progress towards SDG Goal 7 in ensuring access to affordable, reliable, and modern energy. Renewable energy is making impressive gains in the electricity sector as shown in Fig. 4 (UN, 2017). Tanzania, an African country listed as a middle-income economy, attested that these achievements are attributable to access to reliable energy (Petersen, 2017).

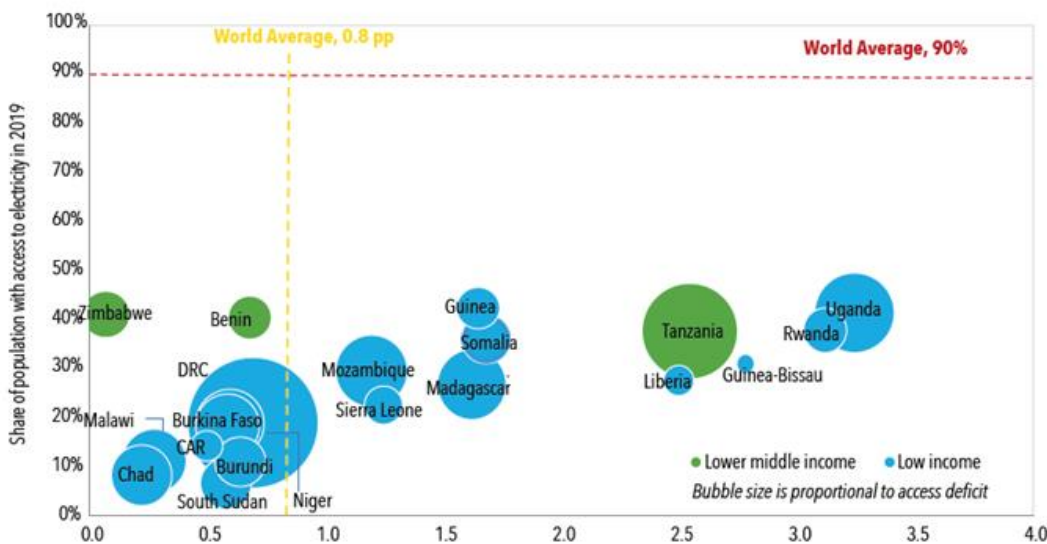

Figure 4: Electricity in the 20 least-electrified countries, 2010-19 (W. Bank, 2020)

In Tanzania, 29% of the population had access to electricity in 2018, out of which those who lived in rural and poor households represented only 7% (A.development Bank, 2020). The country has 66% of its population living in rural areas, indicating that a great number need electricity. This brings attention to the government to implement the adoption of renewable energy to fulfill the electricity needs of the population. Solar mini-grids have been adopted for their potential to provide reliable electricity in rural areas while decreasing costs and GHG emissions and increasing the reliability of electricity (Kilischekow, 2021). They are referred to as alternative energy sources because they are an environmentally-friendly, secure, affordable, modern, and sustainable manner that can eliminate Tanzania's energy problems (Bishoge *et al.*, 2018).

The Tanzanian Government's vision is to ensure that by 2030, 70% of its population will be having access to electricity, 50% of which is to be derived from renewable energy sources (Shippe, 2021a). Investment in renewable energy has made significant achievements in the country, For instance, one of the projects of Lighting Rural Tanzania enabled the low-income population to access clean and safer off-grid lighting energy by installing solar home systems for 6.5 million people in the country by the end of 2019 (Shippe, 2021b). Similarly, the Jumeme Solar-Powered Mini Grid project launched in the country helped two thousand households, over 200 businesses, and 1000000 people living around the Lake Victoria Island of Ukara to access electricity. The Jumeme project still has the goal of serving up to 1 million people in rural areas across Tanzania by 2022 (Energy4Impact, 2016). Tanzania's renewable energy usage shows its penetration. Therefore, there is a need to monitor its usage to enhance its consumption by society.

2.3 Monitoring Renewable Energy

Renewable energy started evolving because it is clean and sustainable. Investing in renewable energy has increased the economic opportunities in many countries. With the increase in the number of consumers, there is need to know its consumption for better usage and energy saving (Scharich *et al.*, 2017).

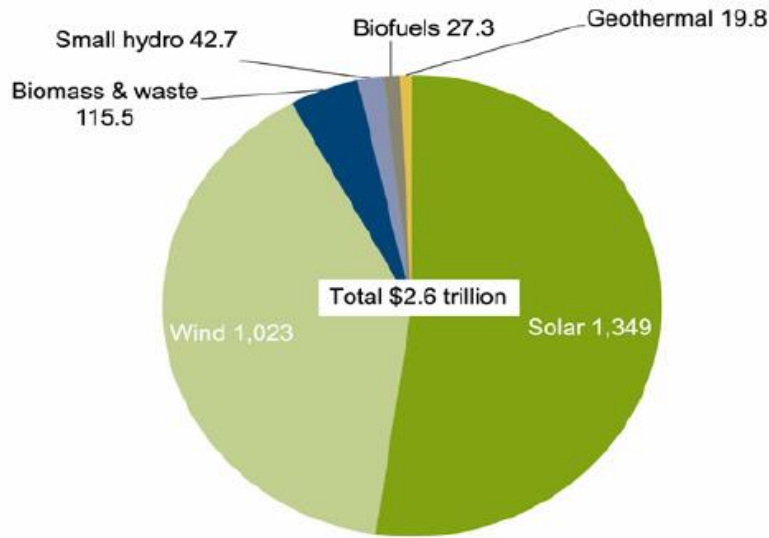

Figure 5: Renewable energy capacity investment 2010-2019 (Scharich et al., 2017).

Figure 5 shows that among existing renewable energy sources, solar energy has been evolving from 2010 to 2019 and has contributed more to rural electrification. This made the International Energy Agency call solar the new king of electricity markets which is expected to further increase from about 1 TW in 2022 to 1.9 TW in 2025 (SolarPower Europe, 2019). This brings more intention to researchers to take action for innovative ways of monitoring its usage, consumption, and performance for real-time alerts to facilitate quick responses in case of faults.

2.4 Related Works

Voltage fluctuations of batteries in consumption that decrease their lifespan is a challenge to users and impacts human activities, human health, and the environment (Kai Liu *et al.*, 2018). The use of renewable energy has made many researchers to adopt ways of monitoring voltage fluctuations to improve usage. The estimation of a battery's voltage level during its consumption is important since the information can be used to facilitate easy maintenance, fault detection, and minimize unexpected power outages (Büscher, 2020).

Several measuring components have been used to monitor voltage fluctuations in batteries where installed. Voltage changes in batteries have been reviewed and conducted to identify battery parameters that can be risky due to voltage changes to improve the economic and sustainable use

of the energy contained in them (Mahammad A. Hannan, Hoque, *et al.*, 2018). One recent approach involves the integration of an Arduino microcontroller board with a thermometer, and voltmeter, and ammeter sensors through a correlation and regression algorithm to measure the battery's state of charge and estimate its useful remaining life (Maltezo *et al.*, 2021). The study showed that the estimation of a battery's state of charge and health, discharge rate, and remaining useful life can be derived in real-time and its parameters recorded to a Secure Digital (SD) card module. However, the proposed system failed to estimate the residual battery voltage for continued performance and presented a low real-time data acquisition due to the usage of an SD-card which lacks efficiency in data security, hence required manpower. Therefore, there is need to develop a low-cost, efficient battery voltage-level monitoring system to increase the sustainable utilization of the voltage stored in the battery remotely.

A battery's state of charge and health in discharge and overcharge are the key factors that contribute to voltage fluctuation risks. Voltage level monitoring systems that use artificial intelligence to ensure battery efficiency and reliability in operation have been used (Faisal *et al.*, 2019). Using the fuzzy logical control system, batteries' states of charge and power balance were evaluated as a way of controlling degradation. Mohammad *et al.* (2017) conducted an automated modularization test on lithium-ion battery cells of 25.5Ah and 3.5V using an equalization algorithm where the safety and battery life cycle operation range proved effective on performance. Azzollini *et al.* (2018) applied nonlinear programming optimization to model battery energy storage using simulation software.

Liu *et al.* (2019) conducted a review on modeling and estimation of battery charging performance using an optimization algorithm. The review showed a result on modeling the internal battery's state of change and health, and internal temperature. Dhaked *et al.* (2019) conducted a simulation work on discharge and charging of battery banks for telecom sites in India using the MATLAB algorithm. Similar work conducted by Krishna *et al.* (2020) in India aimed at controlling voltage drops of battery banks installed in electrical vehicles. However, these works were limited to simulation. The study conducted by Diao *et al.* (2017) determined the battery life in an electrical vehicle by comparing and analyzing its state of health with its actual state and capacity of power. The study proved that the state of a battery is more suitable and accurate in reflecting its actual

state. However, it is necessary to conduct a study that will increase data visualization of a battery's state by considering most parameters that are risky to it through a dashboard while taking advantage of the technological evolution advance on real-time data access.

An approach including machine learning was used to assess and analyze the battery life cycle where it was deployed. In electronic vehicles, a test was conducted by Liu *et al.* (2018) on two lithium-ion batteries using an unscented particle filter (UPF) algorithm which displayed the results of voltage, current, and temperature through an online health indicator to determine battery degradation. However, the system failed to monitor the battery's conditions while in operation. Another study used the neural network approach to analyze the remaining useful battery life by estimating its capacity and state of health using data from the National Aeronautics and Space Administration (NASA). The approach presented a high accuracy on single voltage data of 58% using Forward Neural Network (FNN), 46% using Convolutional Neural Network (CNN), and 25% Long Short Term Memory (LSTM) (Choi *et al.*, 2019). Neural network types were also used to predict battery aging (Tang *et al.*, 2020). Another approach conducted by Hannan *et al.* (2018) used neural networks and presented high accuracy on battery evaluation of the state of charge. However, the complex technological methodology used in this system was suitable only for experienced users which excludes its adoption by low-skilled users.

A study based on the Raspberry Pi module in a smart microgrid was also used to monitor the battery performance and operational voltage, temperature, and current to know the state of charge. Transport Control Protocol/Internet Protocol (TCP/IP) was used for digital communication (Friansa *et al.*, 2017). A similar methodology analyzing the fault diagnosis for large-scale measuring of the battery voltage, current, and temperature was conducted by Kim *et al.* (2018). The IoT gateway used TCP/IP for long-range and wireless communication to reduce wire harness issues by increasing its scalability and improving its productivity. Zigbee was used for short-range radio and Bluetooth transmission for low power. However, the low speed of data transfer presented in these previous studies showed the need to avoid the low reliability of TCP/IP protocol for cloud control.

(W. Li *et al.*, 2020) developed a cloud battery management system to monitor battery aging while considering parameters of capacity and power fade. Similar work that presented an online cloud-

based battery monitoring for e-vehicle was proposed by Senthilkumar *et al.* (2021). Battery current, voltage, and temperature were monitored and android applications were used to access the battery health and state of charge. However, the system considered only one geographical area, allowing users to monitor and access battery parameters installed in small electric vehicles but excluded the monitoring of batteries installed in towers. Another study by Kait and Mohite (2021) developed a system that used a short message notification to provide daily information on battery consumption, acid level, voltage, and temperature. Battery information was processed by ATmega328 and displayed on a Liquid Crystal Display (LCD). However, the study presented a low-efficiency platform for accessing the processed data since the data was displayed on LCD which was not effective for users.

Furthermore, (Kumar *et al.*, 2018) benefited from the advancement of IoT and developed a system using Global System for Mobile (GSM) communication to enable battery users to monitor the residual level of charge through a smartphone and a General Packet Radio Service (GPRS) for tracking degradation area. The GSM approach was used to send notification alerts to users. With the developed system, degraded batteries were intelligently detected using GPRS coordinate locations (Helmy *et al.*, 2018). A study was conducted by (Bendale, 2021) where battery voltage information was monitored over a wide area and long-distance using the GSM communication module. However, the information provided to users was insufficient to eliminate the battery hazards during consumption.

Several existing studies are currently considering changing a few parameters like current, temperature, and the state of health of batteries as the most provocative for voltage fluctuation, especially for batteries installed in electric vehicles which is only beneficial to one section of battery users. Besides, other studies use high technological methods which scare most users from adopting them due to their high market costs and requirements for high technical skills. To eliminate these challenges, the present project proposed a low battery voltage-level monitoring system that can be beneficial to all battery users. The developed system can be used in accessing battery information remotely by allowing users to continue monitoring battery usage in real-time, hence contributing to the elimination of battery hazards.

CHAPTER THREE

MATERIALS AND METHODS

3.1 Introduction

This chapter provides the details of the materials and methods used in this study. It outlines the way the system was developed and validated starting from the area of study, research method, data collection methods, data analysis, system development approach with system testing, validation, and implementation.

3.2 Area of Study

This study was carried out at two (2) towers of Habari Node Public Limited Company which is an internet service provider (ISP) in Arusha, Tanzania as shown in Table 1.

Table 1: Tower location coordinate

S/N	Location	GPRS Tower Coordinate	
		Latitude (LAT)	Longitude (LONG)
1.	Ngorongoro	-3.27544	35.438886
2.	Manyara	-3.37764	35.81857

The coordinates of the towers were measured using a GPRS device, one located at Ngorongoro and the other at Manyara. The two towers were selected due to their ability to store energy through batteries for powering the tower using solar batteries. The selection was also based on voltage fluctuations and a huge number of users who reside far from company offices. The coordinate measurements helped in sending data to the towers accurately without any loss. Furthermore, the measured coordinates assisted in system installation and the testing process in the field.

3.3 Research Methods

A qualitative research method, through a semi-structured interview, was used. The interview questions were grouped into 4 sections: The first section consisted of open-ended questions regarding the favorable place for the interview and understanding their departments. The second section had introductory questions. The third section had key questions focusing on the challenges posed by the traditional approaches in the company. The last section focused on collecting relevant information. The interviews were conducted in the Habari Node meeting office next to the server and took approximately 1 hour to complete. The feedback from respondents was recorded by taking notes and pictures.

3.4 Target Population and Sample Size

The interview questions were focused on groups of 5 people from the Habari Node Public Limited Company, one being the tower coordinator responsible for access to all towers, and the other four, tower technicians. The selection was done based on the potentiality of participants in managing the performance of the company towers daily which helped in selection of 2 most towers due to unmonitored voltage level of battery in discharging and charging.

3.5 Sampling Techniques

The non-probability technique was used in this study to select key participant interviewees to successfully gain detailed insights on the challenges faced by the company affected when using the manual approach in monitoring batteries installed in the towers. Furthermore, documented analyses such as published manuscripts from reputable journals were reviewed to find the contribution of the existing systems and limitations to develop this system.

3.6 Data collection methods

3.6.1 Primary Data

The voltage levels of the installed batteries and solar panels in the tower were measured. The current flowing through the batteries and solar panels was measured manually using a digital multimeter Alternating Current (AC) Direct Current (DC) UNI-T UT890D. The measurements were done on two batteries located in the different towers as shown in (Table 2). The results present

a mix of used and full batteries with different values. Furthermore, the cutoff times were observed based on the voltage stored in the batteries. The measurements helped in the development and real-world application of the developed system.

Table 2: Manual measurement results

Battery Location	Voltage				Results Time (hrs.)
	Battery	Solar	Load	Low voltage	
Ngorongoro	14.8V	20V	0.05	11.88V	6
Manyara	14.5V	20V	0.07	11.8V	4

Fig. 6 shows different 12V rechargeable solar batteries used in prototype development and testing which had the same voltage as the battery installed in the tower with an AC/DC digital multimeter to measure the AC and DC.



Figure 6: Digital Multimeter with batteries

3.6.2 Secondary Data

Documented tools were used for obtaining better insight on the challenges faced when manually monitoring battery voltage-level and limitations of existing systems. Internet search through search websites, online books, and scientific papers published in peer-review journals was used to review the gaps in the existing systems.

3.7 Data analysis

Analyzing data was based on understanding the current traditional methods used by the company, their challenges, and their limitations. Key participants at Habari node public limited company were interviewed, Observation and reading of related articles on the previous work done in this area were also done. After getting better insight regarding the traditional methods, the decision of developing a low battery-voltage level monitoring system that could be adopted by the telecommunication tower engineers to reduce voltage fluctuation risks like injuries, environmental degradation, and deaths was proposed.

3.8 System Development Approach

3.8.1 XP Agile Method

Software development model is an important technique for system developers. They are different based on the aim of the system and are used for the identification of system needs for maintenance (AltexSoft, 2021). They are used to break down the system life cycle for managing and controlling the software. Agile and Waterfall have proven to be popular. The present study used extreme programming (XP) agile methodology due to its ability in allowing users to measure the progress of system iteration units and allowing requirements changes, avoiding bugs while minimizing the risks for delivery of high-quality system production.

Waterfall proved easy to understand but difficult to use in measuring the system iteration progress. It required every iteration to be 100% completed before starting to perform the next iteration which eliminates rolling back to change an iteration, making it costly. Its use would decrease the aim to develop a low-cost battery voltage-level monitoring system for telecommunication towers as shown in Fig. 7.

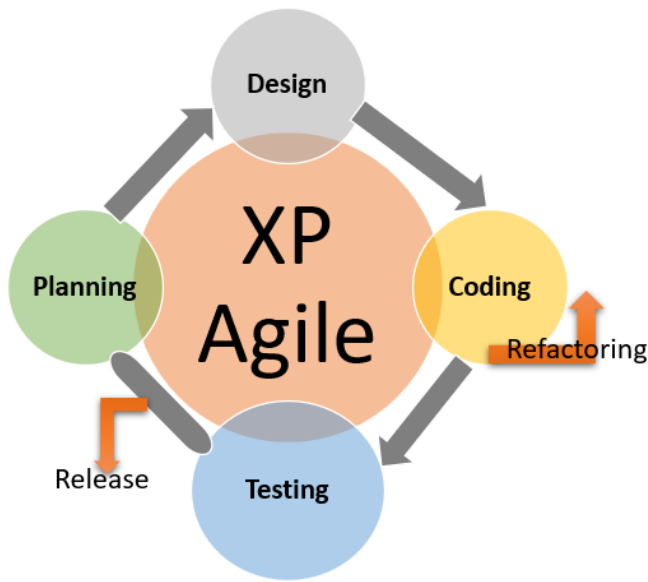

Figure 7: Extreme Programming diagram

3.8.2 System Analysis

i) Hardware components Simulation

After data collection, verification of the hardware part was done using the Proteus simulation software. Figure 8 shows the system overview design in the circuit which consisted of a voltage sensor, current sensor, gas sensor, flame sensor, an Arduino Uno microcontroller board, SIM808 GSM/GPRS/GPS module, and a 14.8V to 14.5 V battery for power supply and a 20V solar panel. The simulation was done before the real application of integrated circuit components to ensure efficiency. The components were integrated into the Proteus software. Arduino Uno, an open-source electronics platform that is easy to use due to its ease in sending instructions to the microcontroller board, was selected based on its efficiency in developing a low-cost system. It consists of 14 digital input and output pins alongside 6 analog pins that use an analog converter.

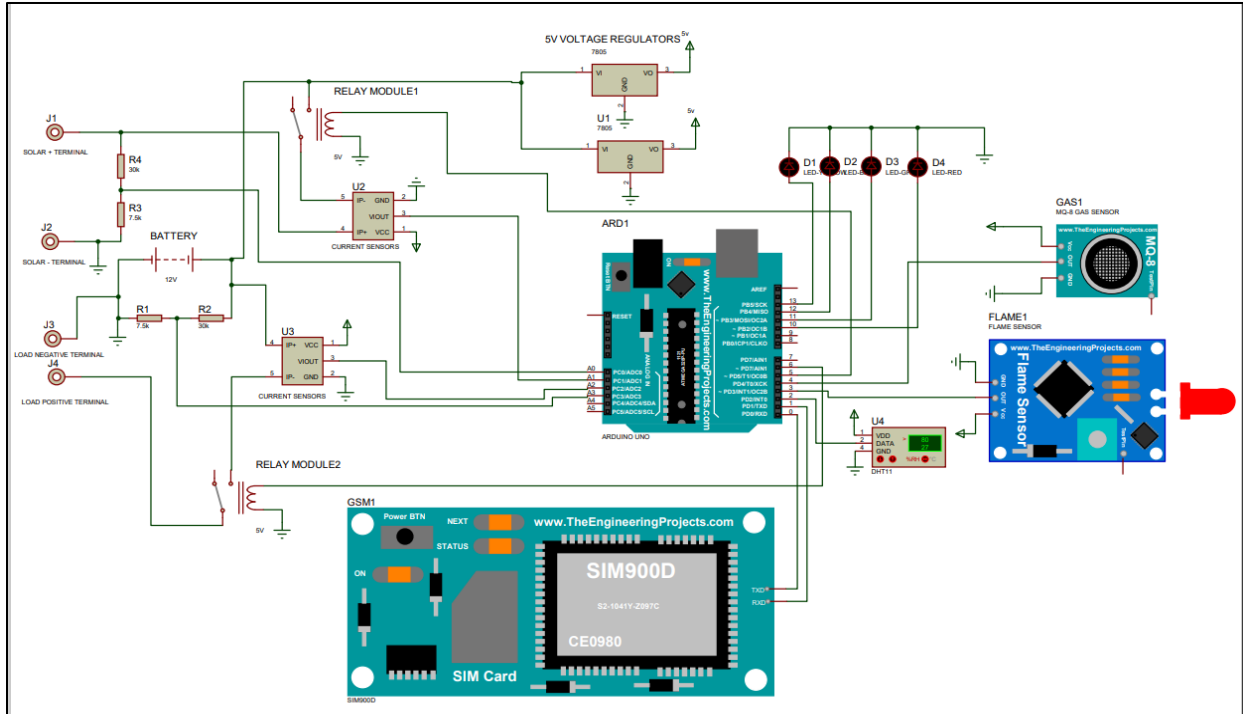

Figure 8: Hardware testing in proteus software

The voltage sensor which acts as a voltage divider was connected to measure the voltage level of the batteries and solar panels. The GSM module transmitter (Tx) and receiver (Rx) pins were connected to pins 0 and 1 respectively. The fire sensor was connected to pin 2 of the Arduino for sensing the presence of fire from the battery. The gas sensor was connected to pin 10 to sense gas. Furthermore, two relays were connected, one to allow the voltage from the solar panel to go to the battery and the second one to allow the load to function. The load used was a bubble light, tested at 5V at Ngorongoro and 3V at Manyara.

Four Light-emitting diodes (LED) indicators were used to alert the user of any occurrence around the battery installation areas, red ones to represent hazard, blue for network connection, yellow for relay, and green for power. Long leg pin was connected to pin 10 of the Arduino and set to output leaving the GSM module. Other components were supplied with an energy of 5V from the Arduino board. The GSM was powered by 12V.

ii) Calculation

The calculations shown in this section were used to produce reliable and accurate voltage information from the batteries and solar panels. The values read by the analog pin of Arduino were converted and the voltage stored in the battery was considered to be battery voltage: Let the value to be read by the analog pin be Analog to Digital Converter (ADC)-Voltage Value as shown in Equation (1).

$$ADC \text{ Voltage Value} \times \frac{5}{1024} \quad (1)$$

Where ADC represents Analog to Digital Converter, 5 is the reference voltage of Arduino, and 1024 is the ADC resolution. The formula for calculating the Voltage divider is shown in Equation (2).

$$\frac{R3}{R3+R4} = Ratio \quad (2)$$

Where R3 is the second Resistance and R4 is presented as resistance one as shown in Fig. (4). R4 in this work was 30 Kilohms and R3 was 7.5 Kilohms. Therefore, the voltage divider is 37.5 Kilohms. The ADC voltage is calculated as shown in Equations (3) and (4) and Fig. 4.

$$ADC \text{ voltage} = \frac{R3}{R3+R4} \times Battery \text{ Voltage} \quad (3)$$

Therefore:

$$ADC \text{ voltage} = \frac{7.5 \text{ Kilohms}}{37.5 \text{ Kilohms}} \times Battery \text{ Voltage} \quad (4)$$

From Equation (1), the ADC-Voltage is calculated as shown in Equation (5).

$$ADC \text{ Voltage} = ADC \text{ value} \times 0.00489 \quad (5)$$

Substitution of ADC-Voltage in (3) gives (6).

$$ADC \text{ Value} \times 0.0049 = \frac{7.5 \text{ Kho}}{37.5 \text{ Kho}} \times Battery \text{ Voltage} \quad (6)$$

Therefore, $0.02444 \text{ ADC-Value} = \text{battery voltage}$ means solar –voltage is shown in Equation (7).

$$\text{Solar – voltage} = 0.2445 \times \text{ADC Value} \quad (7)$$

Therefore, the voltage constant used in the code battery was 0.02499999 and 0.02499989 for the solar constant. Fig. 9 shows the resistance of the voltage divider used in the calculation.

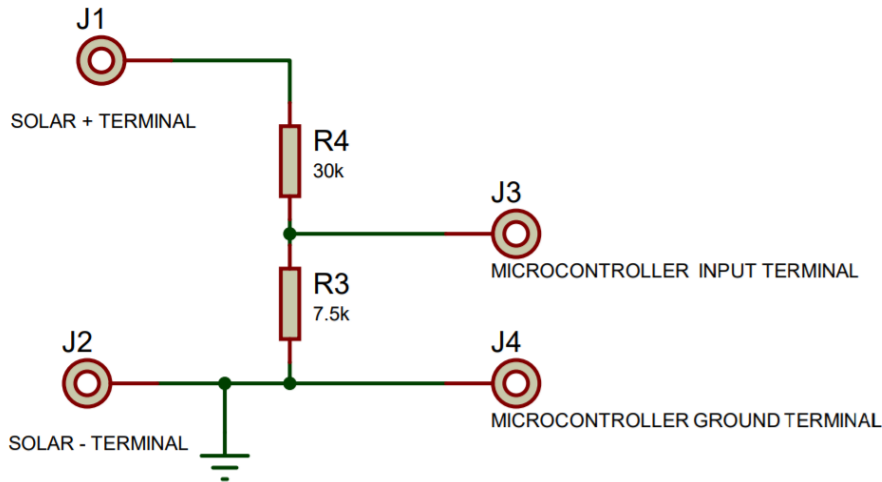

Figure 9: Voltage divider

3.8.3 System Design

i) Hardware Integration

Following system simulation, the hardware components were integrated for real-life application and interactions proved system functionality and compliance with requirements as intended. Fig. 10 shows the system hardware components integration of the GSM and the sensors in waterproof.

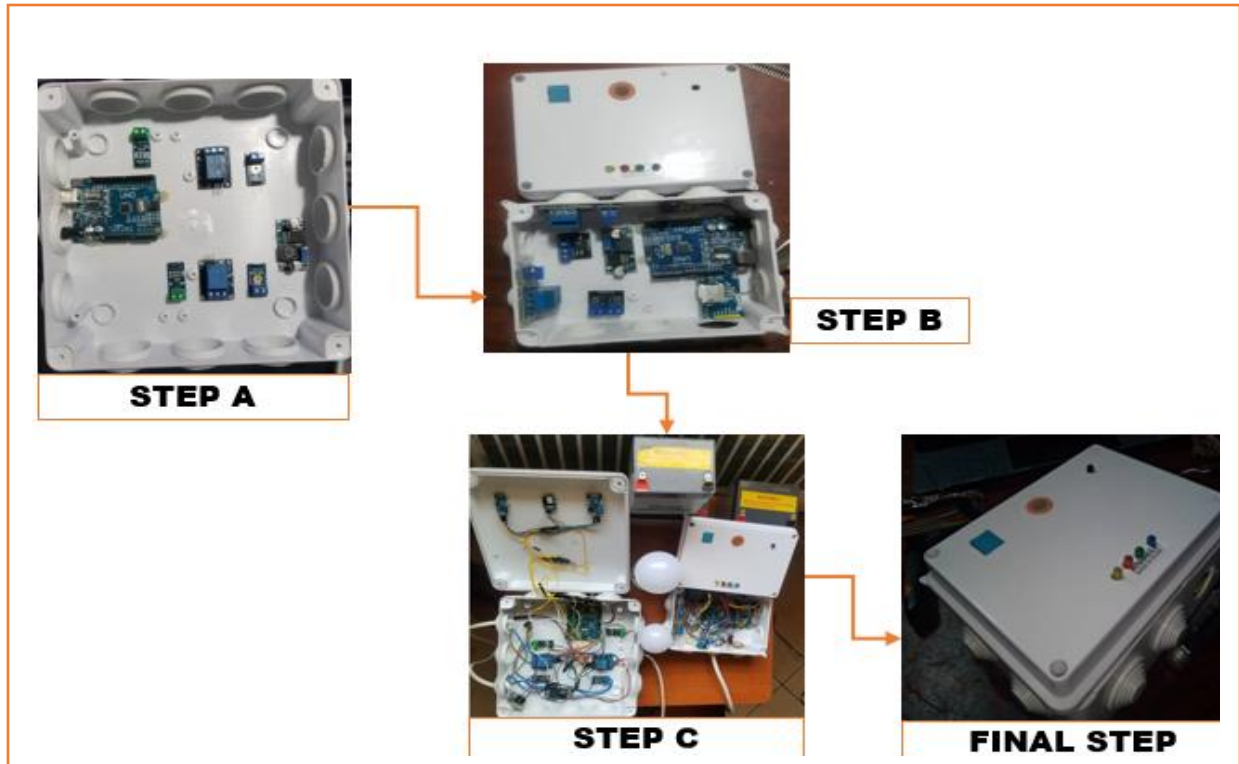

Figure 10: System hardware components integration

ii) Functionality of the system

Figure 11 shows the flow of sensed data. The system started by checking the values of the current and voltage, and then compared the actual value with the available value, voltage value, and current value which was sent to the server and displayed to the dashboard of mobile. If the voltage of the battery was $< 11.8V$, a Short Message Service (SMS) notification was sent to the user to turn on the solar panel to recharge the battery; if it was $> 11.8V$, the battery was safe and the system kept checking the actual value with the available respectively.

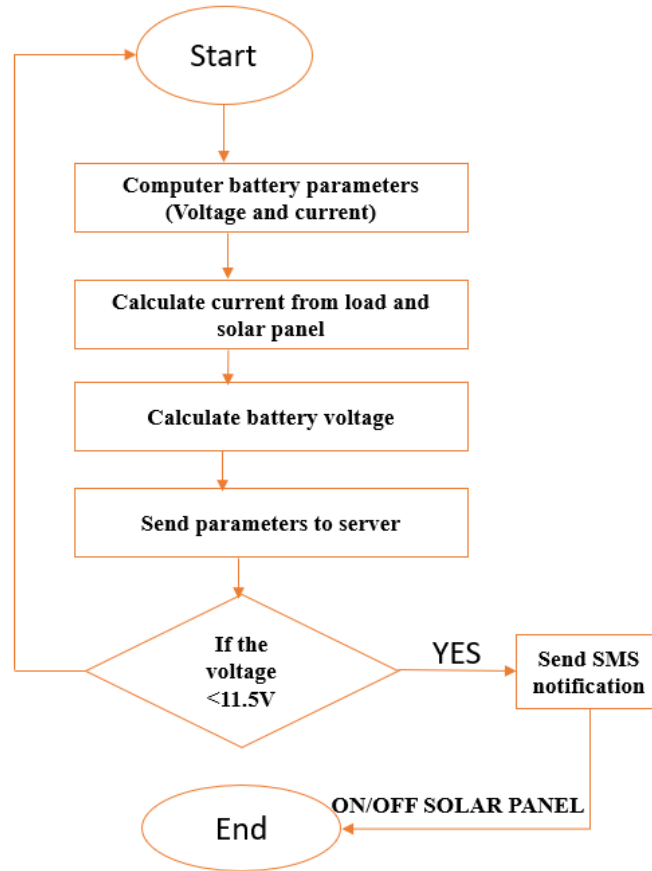

Figure 11: System Flowchart

3.8.4 System Development

i) Software and Programming language

The software development used was an Arduino Integrated Development Environment (IDE) as an editor which helped in executing and compiling the code in the elimination of error before uploading the code to the hardware. The C programming language, as a general-purpose high-level computer programming language, was used to instruct the hardware components in sensing the environment. Hardware libraries such as DHT 11 were imported into the IDE and the programmed output was displayed on an Arduino IDE serial monitor.

Data were continuously monitored through a mobile application dashboard developed for this study by the name of Rahab Power manager as shown in Fig. 12.

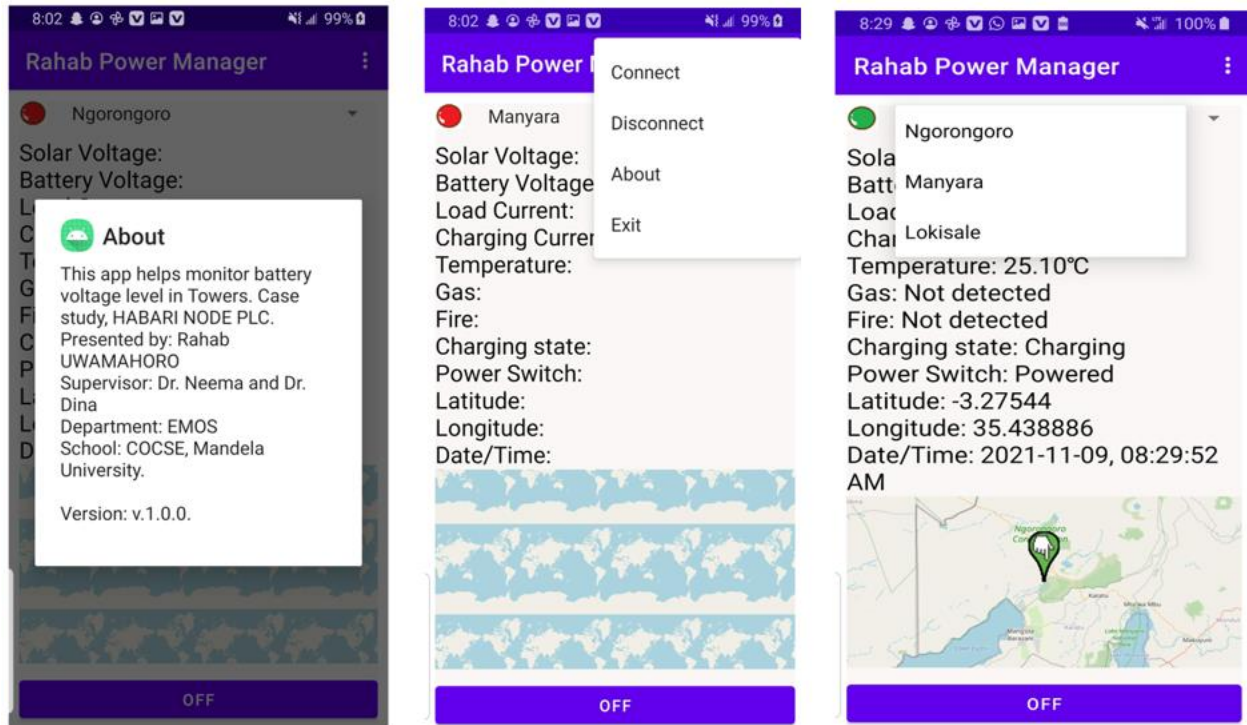

Figure 12: Mobile dashboard interface

The data was sent to the dashboard in real-time and a user could command the relay to turn the battery and the solar panel on and off in case of hazardous incidents like fire and gas in the tower. The software used in the development of the mobile app had a minimum system requirement of android 18 with a target operating system of android 30 built based on the Android Operating System (OS). Data were displayed as text with GPRS locations being displayed on a map with a remote power control button.

ii) Hardware components description

Arduino Uno

Arduino Uno, a microcontroller board, is a viewable software code changeable by the public due to its free open-source code for the public. The board includes 14 digital input and output pins with digital pins having only two values 1 or 0 (ON or OFF) and an analog signal that can scale its value in the range from 0 - 255 as shown in Fig. 13. Powering the board battery or the AC to DC adapter

can be used at 5V. In this project, the board was used to process and analyze the collected data from sensors. The selection was due to its simplicity of use and low cost which made it compatible with the software and hardware systems compared to other microcontroller boards like Arduino mega that are hardcore electronic and not highly compatible with software for small projects (Elprocus, 2019).

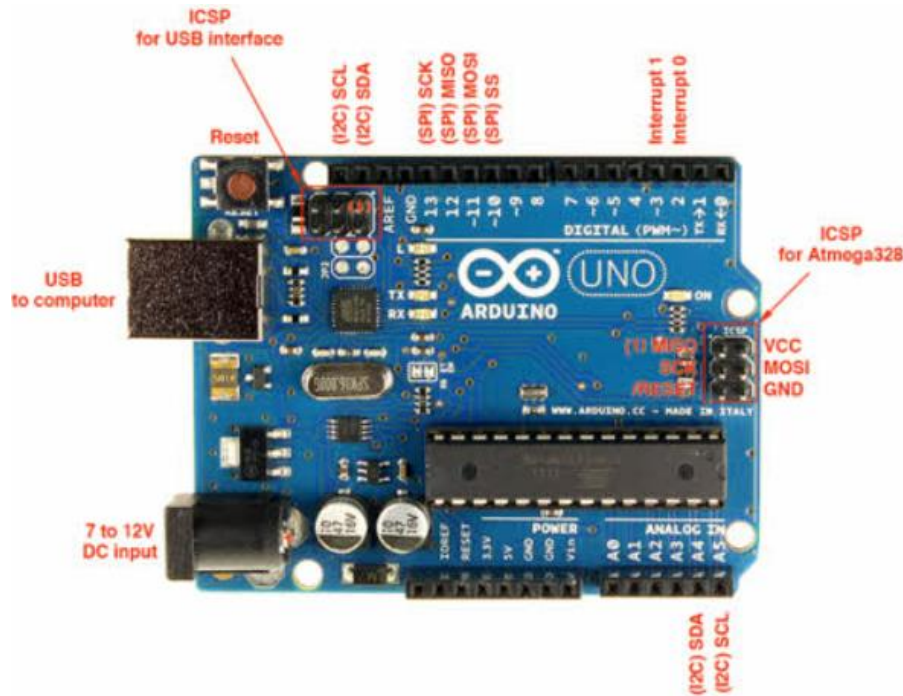

Figure 13: Arduino Uno

Relay

Relay is an electromechanical device that uses electromagnetism to function as a switch (Gautam, 2020). In this work, a total of 2 relays powered by 5V were used for every node to regulate voltage from and to a battery and solar panel based on instructions received from Arduino Uno as shown in Fig. 14. One relay was used to allow electrical currents from the solar to charge the battery. The other relay was used to allow the electrical power from the battery to go to the 5V solar light used as the load in this work.



Figure 14: Relay

Buck converter (LM 2596 S DC)

Figure 15 shows an LM 2596 S known as step-down switching regulator integrated circuit that converts direct current supplied at an input to the required variable direct current at the output (Bharathi, 2020). In this work, one buck converter was used for every node to step down the 12 V from the solar battery used up to 5V, suitable for the Arduino board and other components except GSM.



Figure 15: Buck converter

Voltage sensor

Figure 16 shows the voltage sensor used to monitor the voltage supplied. It can measure alternate current or direct current and the output voltage that are analog signals or frequency modulated with its measurement and based on the voltage divider (E4U Electrical, 2021). In this study, several 2-voltage sensors were used in every node. One voltage sensor was used to detect the voltage of the battery. The last voltage sensor was used to detect the voltage from the solar panel accurately.



Figure 16: Voltage sensor

Current sensor (ACS 712)

Fig. 17 shows an ACS 712, an important component in the electronic application for managing power usage due to its ability to measure the current through any electronic device. It does this by generating accurately, signal required by a circuit by producing an analog voltage as output proportional to AC (Admin, 2018). In this work, 2 current sensors were used in every node with the first detecting the charging current from the solar panel and the second one the current going into the 5V solar light that acted as the load.

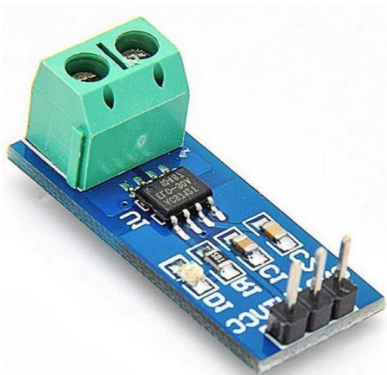

Figure 17: Current sensor

GSM Module

In this project, internet connectivity for every node was provided by GSM as shown in Fig. 18 for storing and collecting data to the cloud and allowing the user to receive and access data remotely through data visualization. During low battery voltage-level with other parameters like detection of fire, gas, high temperature and fault in charge and discharge of current to the solar panel and

the load which are risky to the tower, with the help of GSM, users were alerted by receiving SMS notifications to recharge or swap the low battery and act accordingly.



Figure 18: GSM Module

Flame sensor

Fig. 19 shows a flame sensor as an electronic device that can detect fire with a wavelength between 760-1100 nanometer (nm) (ThemeGrill, 2020). In this project, the flame sensor was used to detect the fire source in the tower and send data to Arduino to be processed in the reduction of fire incidences in the tower.

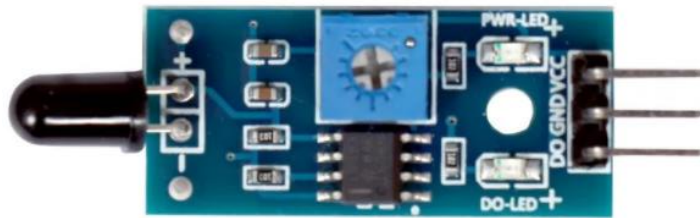

Figure 19: Flame sensor

Gas sensor (MQ-3)

The gas sensor shown in Fig. 20 measures the concentration of the gases in the air to prevent toxic exposure and fire. They are used for safety purposes and their response serves as the scale. The gas sensor activated an alert to the user when responses that serve as the reference point surpassed

a certain preset level (Thomas Industry, 2020). In this project, the MQ-3 gas sensor was selected due to its ability to sense change based on the resistance of sensing materials when exposed to alcohol whose concentration can be detected. The concentration of gas in the air emitted by the battery in its discharge and charge time consumption and a dangerous gas level was detected.



Figure 20: Gas sensor MQ-3

DHT 11 sensor

Faults in the battery and its attached circuit can affect the temperature of the battery. If its temperature is not monitored and properly regulated, permanent damage can occur due to the increase in battery temperature that results in degradation of the positive plate inside the battery, thus shortening its life and reducing battery performance (AKCP, 2021). The DHT 11 sensor was used to detect the humidity and temperature increase in the tower which can pose harm to the battery as shown in Fig. 21.

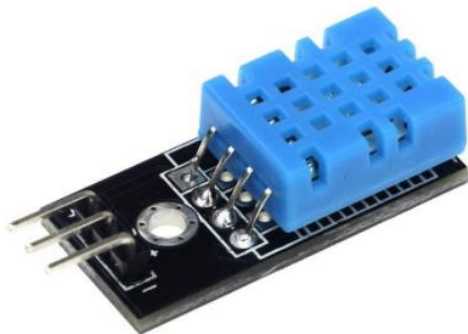

Figure 21: DHT 11 sensor

iii) System testing

System testing was used to ensure that the developed system fitted its purpose and functionality in real-life applications. It involved testing the components specifications before testing the entire developed system as shown in (Table 3). After interfacing and testing every component, the system was tested at the fields and found to perform according to the desired requirements. In this project, lab testing and tower-testing stages were conducted.

Table 3: System Testing summary

S/N	Requirement	Description	Grade
1.	Each node (Manyara and Ngorongoro) was powered by a solar panel battery. Green LED indicator.	Powering status were observed by observing Green LED blinking	Pass
2.	GSM connectivity	Internet was provided by GSM. Users were able to observe the internet availability by blinking of Red LED indicator	Pass
3.	Integration of sensors with Arduino Uno board.	Every sensor was tested and its output observed through Arduino ide serial monitor	Pass
4.	Validation	The accuracy of the developed system was compared with the output measured manually	Pass

Lab testing stage

The lab testing stage is shown in Fig. 22, one node contains the developed system, 5V solar lights were used as load, and a 12 V solar battery that was used in this stage as shown in Fig. 22.



Figure 22: Lab testing stage

Tower testing stage

The stage of tower-testing for the developed system was performed. It sensed the collected data and stored it in the cloud. The stored data was accessible to users through a mobile application dashboard developed (Rahab power manager). Alert of low voltage battery through an SMS notification was sent to the user respectively as shown in Fig. 23.



Figure 23: Field testing stage

3.8.5 System Validation

The process of evaluating software after development to ensure compliance with software requirements was performed to validate the system and user acceptance. The results measured using the manual approach used currently by the company were compared with the results obtained using the present developed low-cost battery voltage level monitoring. The accuracy of the system proved to be efficient in accessing data remotely every 5 seconds and sensed the collected data and stored to the cloud respectively.

CHAPTER FOUR

RESULTS AND DISCUSSION

4.1 Results

This section contains the results of the system's tests and analysis. The voltage sensor experiment was recorded to ensure that the circuit was in good working order, followed by recording experiments and the results used to verify battery voltage fluctuations (Table 4). Analysis was conducted to the developed system and the two batteries located in the respective towers as shown in Fig. 23. The developed system successfully measured the voltage levels and the current from solar panels and the load (Table 4). Furthermore, the system could measure the humidity of the battery and detect gas and fire near the battery. A 14.8V fully-charged battery which reached 11.86V after usage was used for the Ngorongoro tower and 11.85 V used rechargeable solar battery for the Manyara tower. A voltmeter was used to compare the voltage measured manually with the voltage measured by the system (Table 4).

Table 4: Results from the developed system

Battery	Voltage results		Current		Humidity	Gas		Fire	
	Multimeter (V)	Voltage sensor	Solar	Load		Detected	Not Detected	Detected	Not
1.	11.86V	11.87V	20V	0.00	Good	No	Yes	No	Yes
2.	11.85V	11.86V	20V	0.03	Good	No	Yes	No	Yes

The two voltages were found to be the same. This helped in knowing the voltage level of the batteries before they reached low voltage. The GSM could send SMS notifications to the intended users to act accordingly, and other parameters were monitored respectively if a battery experienced low voltage. Figure 24 shows an image of the solar batteries used and the process of testing the system. The measurements taken via a manual approach using a multimeter showed that the voltage levels were different due to the usage of different batteries (Table 3).

Figure 24(a) shows the solar battery used in the experiment, Fig. 24(b) shows prototype testing using a voltmeter and the system, and Fig. 24(c) is a complete prototype with a 5V solar lamp as the load.

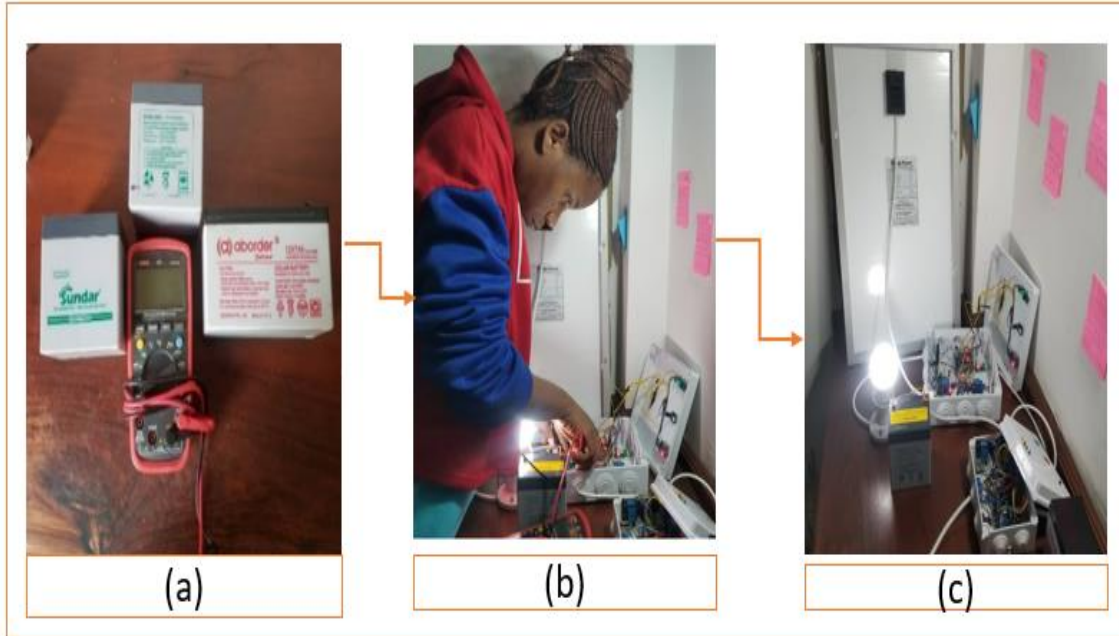

Figure 24: Batteries used with a multimeter and developed system used in testing

The value was accurately similar to the one measured using the system from the multimeter measurements (Table 4). Therefore, the voltage sensor provides valid measurement values of the batteries. Other battery parameters were measured to determine whether there would be a risk to humans and the environment. Using current as an example, the current sensor, loads, and the DC for which a solar panel was used to charge the batteries were respectively measured. The solar panel could charge the battery, and the lamp was used as a load, and its current was measured and monitored respectively as shown in Fig. 24(c). The measured battery parameters were compared with those measured using a multimeter, and the values were accurately similar (Table 4). Each tower had its battery voltage monitoring system, and data was sent to one centralized mobile application dashboard. Figure 25 shows the final prototype of both systems tested for Ngorongoro and Manyara towers.



Figure 25: Final prototype for both towers

4.2 Dashboard Data Results

Data from the sensors were collected and sent to a mobile app dashboard as shown in Fig. 26. Battery parameters were updated in real-time respectively every 5 seconds and stored in the cloud using the ThingsWeb server and also on Arduino IDE serial monitor. The actual voltage and current comparison were used to control the voltage level of the battery installed in each tower. The comparison was made based on measuring the actual battery voltage with the remainder and the current coming from the solar panel to the battery compared to the actual current. Furthermore, temperature, humidity, fire, and gas were continuously monitored to assess whether they were detected or not. As shown in Fig. 26(a), the screenshot of the app developed for monitoring the batteries shows that the approach was effectively evaluated and met the requirements in instances of live data every 5 seconds.

Figure 27(c) shows the screenshot of a message received as an alert to the user about the low voltage of the battery installed at Ngorongoro tower, which enabled the user to turn on the relay. Data was uploaded onto the dashboard and stored on a server. In Fig. 26(c), the load and charging current were presented to be 0.00 since there was no load and the solar panel was not instructed to start charging the low battery.

When the load was connected, and the solar panel started to power the battery, the system efficiently measured the current as shown in Fig. 26(b). However, fire and gas were not detected at Ngorongoro tower shown in Fig. 27(b) and (c) and Manyara tower in Fig. 26(c).

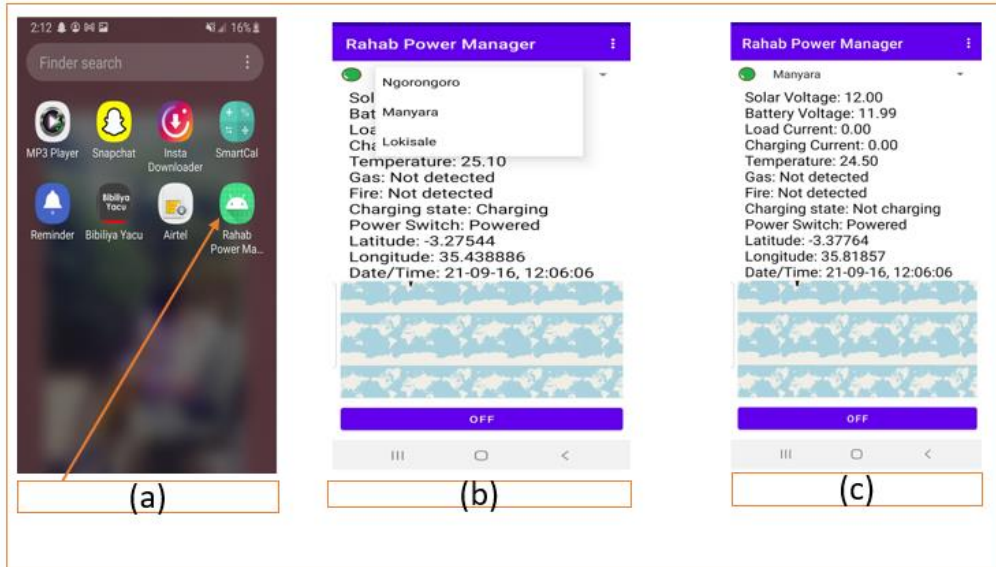

Figure 26: Mobile application for the system and sensed data on the dashboard.

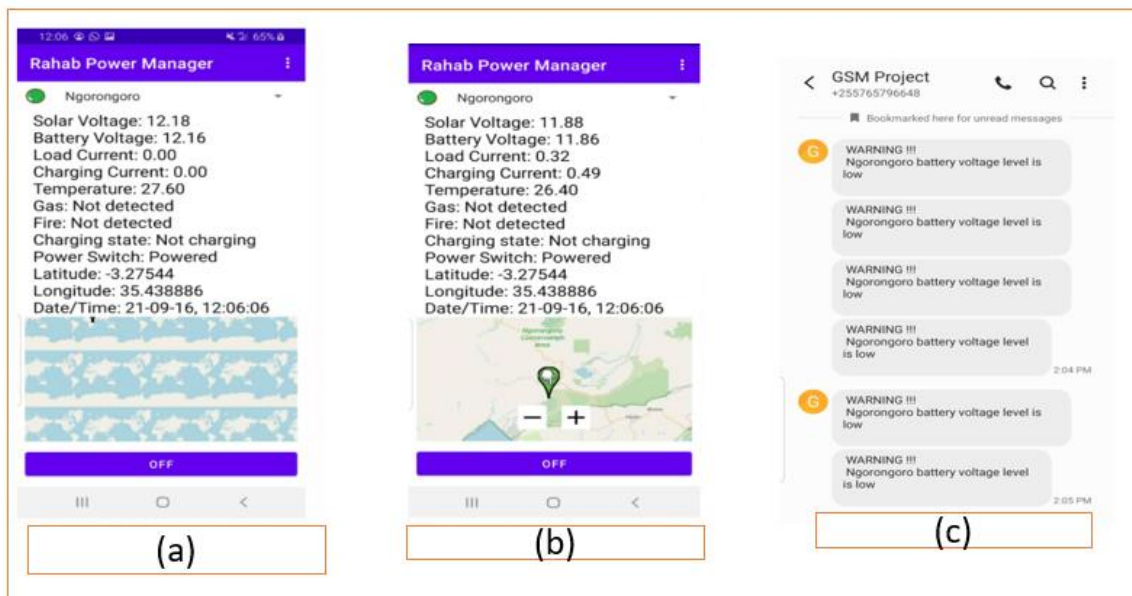

Figure 27: Dashboard and SMS notification sent by GSM (Ngorongoro)

Figure 27(a) shows that battery voltage installed at Ngorongoro were 12v but in its consumption it's reaches on 11.86 v as shown in Fig. 27 (b) and SMS notification were sent to the tower admin as an alert as shown in Fig. 27(c).

From both result lab and field, the proposed system eliminates some limitation presented in existing system as shown in (Table 5).

Table 5: Existing system comparison with Developed system

S/N	Existing system Limitation	Developed System Strength	Grade
1.	No SMS notification for alerting user.	Provided a SMS notification as an alert to the user when voltage level of battery is low.	Pass
2.	The system focuses only one geographical area like especially for batteries installed in electric vehicles which is only beneficial to one section of battery users.	Developed for towers and can be adopted to be used at any place battery are installed	Pass
3.	High technological methods	Low cost	Pass
4.	Use high technological methods which scare most users from adopting them due to their high market costs and requirements for high technical skills	User friendly, reliable and adaptable.	Pass
5.	No centralized system	Present a centralized system to access battery live data every 10 seconds	Pass

4.3 Discussion

The experiments conducted in the field on the selected towers proved the status information from batteries located in the different towers: the voltage and current levels, temperatures, and presence of fire or gas could be monitored and risks of voltage fluctuation reduced. Figures 26 and 27 show that the voltage level and other battery status parameters located at Ngorongoro tower were monitored using sensors and accessed through a mobile dashboard, respectively. Data processed from the sensor were sent to the cloud in real-time as shown in Figs 26, 27(a), and (b) for visualization of battery voltage level, current, temperature, early warning on fire if presented, and gas status data a mobile app dashboard.

CHAPTER FIVE

CONCLUSION AND RECOMMENDATIONS

5.1 Conclusion

This project lays the foundation for developing a battery voltage-level monitoring system for towers to ensure suitable battery performance parameters and real-time monitoring. The development of the system consisted of an integration of sensors for battery monitoring devices and a mobile dashboard application as a user interface which ensures central monitoring to a future-safe greener tower. Battery voltage level monitoring developed proved that the information on where battery is installed can be provided within 10 seconds.

From the limitation found in the previous existing systems, this project addressed these parameters to eliminate those limitations as follow:

- i) The system can send information to the admin mobile dashboard application via ThingsWeb IoT v2.1 a cloud server from related towers using its coordinate locations via the GPRS internet module.
- ii) SMS notification is sent to the user as an alert when the battery voltage becomes low as the fastest way.
- iii) Developed mobile dashboard application allows users to access and monitor the battery in real-time.
- iv) Parameters like fire, excess of gas, temperature and humidity in tower were also monitored.

5.2 Recommendations

From the study findings, this project recommends adopting a battery voltage-level monitoring system by telecommunication towers engineers to reduce voltage fluctuation risks like injuries, environmental degradation, and deaths to increase awareness to the user towards economical battery life usage. This will help engineers monitor the usage of battery voltages in the tower effectively and facilitate individual battery users to access the riskiest parameters where batteries are installed for the sustainability of battery appliances to humans and the environment. Real-time

monitoring and control are highly recommended for those who use the battery to power their devices installed remotely.

The government should encourage the utilization of the developed system to enhance access to data related to where the battery is installed. Finally, future research may focus on adding more functionalities to improve the developed system like adding:

- i) Ethernet that can improve internet connectivity over GSM to eliminate long delay found in sending and receiving tower from the cloud.
- ii) Current prototype testing was done on a single solar battery more directions on more than one battery connected in series will be an added advantage.
- iii) For monitoring gas other sensor that can detect different gases can be used instead of MQ-3.

REFERENCES

- Arndt, M. H. (1932). What Are Batteries. In *Battery Brooding: A complete exposition of the important facts concerning the successful operation and handling of the various types of battery brooders* (pp. 23–34). <https://www.qrg.northwestern.edu/projects/vss/docs/power/1-what-are-batteries.html>
- Azemi, N. L. M., & Wahid, N. (2021). Uncertainty in internet of things: A review. *International Journal of Advanced Technology and Engineering Exploration*, 8(75), 422–431. <https://doi.org/10.19101/IJATEE.2020.762115>
- Azzollini, I. A., Felice, V. Di, Fraboni, F., Cavallucci, L., Breschi, M., Rosa, A. D., & Zini, G. (2018). Lead-acid battery modeling over full state of charge and discharge range. *IEEE Transactions on Power Systems*, 33(6), 6422–6429. <https://doi.org/10.1109/TPWRS.2018.2850049>
- Bank, African development. (2020). *Tanzania - Renewable energy investment facility - Enabling Environment - SEFA Appraisal Report | African Development Bank - Building today, a better Africa tomorrow*. <https://www.afdb.org/en/documents/tanzania-renewable-energy-investment-facility-enabling-environment-sefa-appraisal-report>
- Bank, World. (2020). *Figure of the week: Increasing access to electricity in sub-Saharan Africa*. <https://www.brookings.edu/blog/africa-in-focus/2021/06/18/figure-of-the-week-increasing-access-to-electricity-in-sub-saharan-africa/>
- Bendale, P. S. (2021). *Gsm based monitoring system of ups battery for high power*. 8(4), 4563–4566.
- Bhanutej, J. N., & Naidu, R. C. (2021). A 7-level inverter with less number of switches for grid-tied PV applications. *International Journal of Advanced Technology and Engineering Exploration*, 8(78), 631–642. <https://doi.org/10.19101/IJATEE.2021.874090>
- Bishoge, O., Zhang, L., & Mushi, W. (2018). The Potential Renewable Energy for Sustainable Development in Tanzania: A Review. *Clean Technologies*, 1(1), 70–88.

<https://doi.org/10.3390/cleantechnol1010006>

Blanchard, S. V. F. M. (2019). American, British and Japanese scientists who invented lithium batteries win Nobel Chemistry Prize | Daily Mail Online. *Mail Online*, <https://www.dailymail.co.uk/sciencetech/article-7553875/Scientists-invented-lithium-batteries-win-Nobel-Prize-Chemistry.html>

Bobby. (2014). *History Of Batteries: A Timeline - News about Energy Storage, Batteries, Climate Change and the Environment*. Center, UPS Battery. <https://www.upsbatterycenter.com/blog/history-batteries-timeline/>

Britannica, E. (2021). *Alessandro Volta | Biography, Facts, Battery, & Invention | Britannica*. Encyclopaedia Britannica. <https://www.britannica.com/biography/Alessandro-Volta>

Büscher, J. (2020). *InnoBlog: Why do we need Battery Management Systems?* Inno Energy. <https://www.innoenergy.com/for-students-learners/news-events/innoblog-why-do-we-need-battery-management-systems/>

CEMEX. (2019). *Company Profile - Who We Are - CEMEX*. 1–5. <https://www.cemex.com/about-us/company-profile>

Chakrabarti, M. H., Hajimolana, S. A., Mjalli, F. S., Saleem, M., & Mustafa, I. (2013). Redox Flow Battery for Energy Storage. *Arabian Journal for Science and Engineering*, 38(4), 723–739. <https://doi.org/10.1007/s13369-012-0356-5>

Choi, Y., Ryu, S., Park, K., & Kim, H. (2019). Machine Learning-Based Lithium-Ion Battery Capacity Estimation Exploiting Multi-Channel Charging Profiles. *IEEE Access*, 7, 75143–75152. <https://doi.org/10.1109/ACCESS.2019.2920932>

Dalela, P. K., Basu, S., Singh, A., Majumdar, S., Nagpal, N., & Tyagi, V. (2014). Geo-intelligence based carbon footprint monitoring and prediction of suitable renewable energy technology system for mobile towers. *2014 IEEE International Conference on Advanced Networks and Telecommunication Systems, ANTS 2014*, 1–5. <https://doi.org/10.1109/ANTS.2014.7057244>

- Daly, H. (2018). 1.1 billion people still lack electricity. This could be the solution. In 2018 Jun (Vol. 20). *In World Economic Forum*. <https://www.weforum.org/agenda/2018/06/1-billion-people-lack-electricity-solution-mini-grid-ia/>
- Dhaked, D. K., Gopal, Y., & Birla, D. (2019). Battery Charging Optimization of Solar Energy based Telecom Sites in India. *Engineering, Technology & Applied Science Research*, 9(6), 5041–5046. <https://doi.org/10.48084/etasr.3121>
- Diao, W., Jiang, J., Zhang, C., Liang, H., & Pecht, M. (2017). Energy state of health estimation for battery packs based on the degradation and inconsistency. *In Energy Procedia* , Vol. 142, pp. 3578–3583. <https://doi.org/10.1016/j.egypro.2017.12.248>
- Economist. (2020). *Africa's population will double by 2050 | The Economist*. <https://www.economist.com/special-report/2020/03/26/africas-population-will-double-by-2050>
- Energy4Impact. (2016). *JUMEME launches its first solar powered mini-grid on the lake Victoria island of Ukara, Tanzania | Energy 4 Impact*. <https://energy4impact.org/news/jumeme-launches-its-first-solar-powered-mini-grid-lake-victoria-island-ukara-tanzania>
- Faisal, M., Hannan, M. A., Ker, P. J., & Uddin, M. N. (2019). Backtracking Search Algorithm Based Fuzzy Charging-Discharging Controller for Battery Storage System in Microgrid Applications. *IEEE Access*, 7, 159357–159368. <https://doi.org/10.1109/ACCESS.2019.2951132>
- Friansa, K., Haq, I. N., Santi, B. M., Kurniadi, D., Leksono, E., & Yulianto, B. (2017). Development of Battery Monitoring System in Smart Microgrid Based on Internet of Things (IoT). *Procedia Engineering*, 170, 482–487. <https://doi.org/10.1016/j.proeng.2017.03.077>
- Gao, T., Wang, Z., Chen, S., & Guo, L. (2019). Hazardous characteristics of charge and discharge of lithium-ion batteries under adiabatic environment and hot environment. *International Journal of Heat and Mass Transfer*, 141, 419–431. <https://doi.org/10.1016/j.ijheatmasstransfer.2019.06.075>

- Gitleman, L. (2014). Alessandro Volta. *Paper Knowledge . Toward a Media History of Documents*, 212(1), 82–91. <https://www.jstor.org/stable/10.2307/24931750>
- Hannan, M. A., Lipu, M. S. H., Hussain, A., & Mohamed, A. (2017). A review of lithium-ion battery state of charge estimation and management system in electric vehicle applications: Challenges and recommendations. In *Renewable and Sustainable Energy Reviews* (Vol. 78, Issue May, pp. 834–854). Elsevier Ltd. <https://doi.org/10.1016/j.rser.2017.05.001>
- Hannan, M. A., Hoque, M. M., Hussain, A., Yusof, Y., & Ker, P. J. (2018). State-of-the-Art and Energy Management System of Lithium-Ion Batteries in Electric Vehicle Applications: Issues and Recommendations. *IEEE Access*, 6(c), 19362–19378. <https://doi.org/10.1109/ACCESS.2018.2817655>
- Hannan, M. A., Lipu, M. S. H., Hussain, A., Saad, M. H., & Ayob, A. (2018). Neural network approach for estimating state of charge of lithium-ion battery using backtracking search algorithm. *IEEE Access*, 6(c), 10069–10079. <https://doi.org/10.1109/ACCESS.2018.2797976>
- Hannan, M. A., Hoque, M. M., Peng, S. E., & Uddin, M. N. (2017). Lithium-Ion Battery Charge Equalization Algorithm for Electric Vehicle Applications. *IEEE Transactions on Industry Applications*, 53(3), 2541–2549. <https://doi.org/10.1109/TIA.2017.2672674>
- Helmy, M., Wahab, A., Imanina, N., Anuar, M., Ambar, R., Baharum, A., Shanta, S., Sulaiman, M. S., Sanim, S., Fauzi, M., & Hanafi, H. F. (2018). IoT-Based Battery Monitoring System for Electric Vehicle. *International Journal of Engineering & Technology*, 7(January), 505–510. www.sciencepubco.com/index.php/IJET
- Hiroshi Kawamura, Marcelo LaFleur, Kenneth Iversen, and H. W. J. C. (2020). *Frontier Technology Issues: Lithium-ion batteries: a pillar for a fossil fuel-free economy? | Department of Economic and Social Affairs*. <https://www.un.org/development/desa/dpad/publication/frontier-technology-issues-lithium-ion-batteries-a-pillar-for-a-fossil-fuel-free-economy/>

- Holtzkamp, J.-H. (2018). *How a “Friendly” Solar and Storage Microgrid is Increasing the Standard of Living in Tanzania | Renewable Energy World*.
<https://www.renewableenergyworld.com/storage/how-a-friendly-solar-and-storage-microgrid-is-increasing-the-standard-of-living-in-tanzania/#gref>
- Jayson, J. S. (2014). The Daniell cell, Ohm’s law, and the emergence of the International System of Units. *American Journal of Physics*, 82(1), 60–65. <https://doi.org/10.1119/1.4826445>
- John, B., & Goodenough, H. (2011). Evolution of Strategies for Modern Rechargeable Batteries. *Journal of Power Sources*, 196(2), 022201.
<http://www.ncbi.nlm.nih.gov/pubmed/23652005>
<http://dx.doi.org/10.1038/nmat3367>
<http://stacks.iop.org/0953-8984/20/i=2/a=022201>
<http://stacks.iop.org/0953-8984/20/i=2/a=022201?key=crossref.c203e1ea6897328bd62e22f345a6773e>
<http://dx.doi.org/10.1>
- Kait, S., & Mohite, N. (2021). Wireless Monitoring System of Lead Acid Battery Using GSM Technology. *International Research Journal of Engineering and Technology*, 8(4), 2395-0056.
- Kaur, R., Krishnasamy, V., Kandasamy, N. K., & Kumar, S. (2020). Discrete Multiobjective Grey Wolf Algorithm Based Optimal Sizing and Sensitivity Analysis of PV-Wind-Battery System for Rural Telecom Towers. *IEEE Systems Journal*, 14(1), 729–737.
<https://doi.org/10.1109/JSYST.2019.2912899>
- Kaygusuz, K. (2012). Energy for sustainable development: A case of developing countries. *Renewable and Sustainable Energy Reviews*, 16(2), 1116–1126.
<https://doi.org/10.1016/j.rser.2011.11.013>
- Kilischekow, A. (2021). *LION Smart - The History of Battery Technology: Evolution of Energy Storage*. <https://lionsmart.com/en/history-of-battery-technology/>
- Kim, T., Makwana, D., Adhikaree, A., Vagdoda, J. S., & Lee, Y. (2018). Cloud-based battery condition monitoring and fault diagnosis platform for large-scale lithium-ion battery energy

- storage systems. *Energies*, *11*(1), 1–15. <https://doi.org/10.3390/en11010125>
- Kumar, T. R., Annathai, R. F., & Engineering, E. (2018). *Gps tracking and battery monitoring*. *6*(2), 500–504.
- Lattanzio, R. K., & Clark, C. E. (2020). *Environmental Effects of Battery Electric and Internal Combustion Engine Vehicles*. <https://crsreports.congress.gov/product/pdf/R/R46420>
- Li, Q., Liu, Y., Guo, S., & Zhou, H. (2017). Solar energy storage in the rechargeable batteries. *Nano Today*, *16*, 46–60. <https://doi.org/10.1016/j.nantod.2017.08.007>
- Li, W., Rentemeister, M., Badeda, J., Jöst, D., Schulte, D., & Sauer, D. U. (2020). Digital twin for battery systems: Cloud battery management system with online state-of-charge and state-of-health estimation. *Journal of Energy Storage*, *30*(April), 101557. <https://doi.org/10.1016/j.est.2020.101557>
- Liu, D., Yin, X., Song, Y., Liu, W., & Peng, Y. (2018). An on-line state of health estimation of lithium-ion battery using unscented particle filter. *IEEE Access*, *6*, 40990–41001. <https://doi.org/10.1109/ACCESS.2018.2854224>
- Liu, K., Liu, Y., Lin, D., Pei, A., & Cui, Y. (2018). Materials for lithium-ion battery safety. *Science Advances*, *4*(6). <https://doi.org/10.1126/sciadv.aas9820>
- Liu, K., Li, K., Peng, Q., & Zhang, C. (2019). A brief review on key technologies in the battery management system of electric vehicles. *Frontiers of Mechanical Engineering*, *14*(1), 47–64. <https://doi.org/10.1007/s11465-018-0516-8>
- Lucien, B. Y., Byiringiro, J. B., Abraham, B. W., Aristide, G. B., & Célestin, K. (2021). Evaluation of the Criteria in the Choice of Energy Storage or Non-Storage in Photovoltaic Systems in the Sahelian Zone. *Energy and Power Engineering*, *13*(06), 236–242. <https://doi.org/10.4236/epe.2021.136016>.

- Magnet academy. (2014). *Planté Battery – 1859 - MagLab*. MAGLAB HOME. <https://nationalmaglab.org/education/magnet-academy/history-of-electricity-magnetism/museum/plante-battery>
- Maltezo, M. R. C., Thio-Ac, A. C., Castillo, A. M. C., Gattu, L. E., Hernandez, C. E. A., Labuan, J. J. C., Navales, L. F., Sopena, E. C., Arago, N. M., Galido, E. A., Madrigal, G. A. M., Pascion, C. G., & Tolentino, L. K. S. (2021). Arduino-based battery monitoring system with state of charge and remaining useful time estimation. *International Journal of Advanced Technology and Engineering Exploration*, 8(76), 432–444. <https://doi.org/10.19101/IJATEE.2021.874023>
- McBreen, J. (1981). Introduction. *Secondary Batteries*, 303–304.
- Nedjalkov, A., Meyer, J., Köhring, M., Doering, A., Angelmahr, M., Dahle, S., Sander, A., Fischer, A., & Schade, W. (2016). Toxic gas emissions from damaged lithium ion batteries-analysis and safety enhancement solution. *Batteries*, 2(1). <https://doi.org/10.3390/batteries2010005>
- Nishi, Y. (2001). Lithium ion secondary batteries; Past 10 years and the future. *Journal of Power Sources*, 100(1–2), 101–106. [https://doi.org/10.1016/S0378-7753\(01\)00887-4](https://doi.org/10.1016/S0378-7753(01)00887-4)
- Odarno, L., Sawe, E., Swai, M., Katyega, M. J. J., & Lee, A. (2017). Accelerating Mini- Grid Deployment in Sub-Saharan Africa- Lessons from Tanzania. *World Resoure Institute*, 1–7.
- Paul Flowers (University of North Carolina - Pembroke), K. T. (University of D. and R. L. (Stephen F. A. S. U. with contributing authors. T. content produced by O. C. is licensed under a C. C. A. L. 4. license. (2020). *17.5: Batteries and Fuel Cells - Chemistry LibreTexts*. Textbook Content Produced by OpenStax College Is Licensed under a Creative Commons Attribution License 4.0 License. [https://chem.libretexts.org/Bookshelves/General_Chemistry/Chemistry_\(OpenSTAX\)/17%3A_A_Electrochemistry/17.5%3A_Batteries_and_Fuel_Cells](https://chem.libretexts.org/Bookshelves/General_Chemistry/Chemistry_(OpenSTAX)/17%3A_A_Electrochemistry/17.5%3A_Batteries_and_Fuel_Cells).

- Petersen, M. (2017). *100% renewable energy is low-cost option for Tanzania to become middle income country*. World Future Council. <https://www.worldfuturecouncil.org/100re-low-cost-option-for-tanzania/>
- Rawat, S., & Arjariya, T. (2015). An efficient Association based Optimization technique for Web pages. *International Journal of Advanced Technology and Engineering Exploration*, 2(5).
- Salkind, A. J., & Brodd, R. J. (1987). Primary and Secondary Batteries. *Proceedings - The Electrochemical Society*, 87-3, 127-145. <https://visblue.com/primary-and-secondary-batteries.html>
- Scharich, N., Schniter, B., Herbert, A., & Islam, M. S. (2017). Battery management system using Arduino. *2017 IEEE Technology and Engineering Management Society Conference, TEMSCON 2017*, 384-387. <https://doi.org/10.1109/TEMSCON.2017.7998405>
- Senthilkumar, M., Suresh, K. P., Sekar, T. G., & Pazhanimuthu, C. (2021). Efficient Battery Monitoring System for E-Vehicles. *2021 7th International Conference on Advanced Computing and Communication Systems, 2021*, 20(6), 833-836. <https://doi.org/10.1109/ICACCS51430.2021.9442038>
- Shippe, S. (2021a). *Renewable Energy in Tanzania: A Way To Fight Poverty*. <https://borgenproject.org/renewable-energy-in-tanzania/>
- Shippe, S. (2021b). *Renewable Energy in Tanzania: A Way To Fight Poverty*. <https://borgenproject.org/renewable-energy-in-tanzania/>
- SolarPower Europe. (2019). *Global Market Outlook - InterSolarEurope*.
- Statista. (2020). • *Africa: population without electricity 2000-2020 | Statista*. Statista. <https://www.statista.com/statistics/1221698/population-without-access-to-electricity-in-africa/>
- Stevens, P. (2019). The battery decade: How energy storage could revolutionize industries in the next 10 years. In *Cnbc* (pp. 1-9). <https://www.cnbc.com/2019/12/30/battery-developments->

in-the-last-decade-created-a-seismic-shift-that-will-play-out-in-the-next-10-years.html

Sugihara, H., Yokoyama, K., Saeki, O., Tsuji, K., & Member, L. (2012). Economic and Efficient Voltage Management Using.pdf. *Ieee Transactions on Power Systems*, 785, 1–10.

Takouleu, J. M. (2020). *TANZANIA: Greenlight energises 1.5 million people with solar kits | Afrik 21*. Afrika21. <https://www.afrik21.africa/en/tanzania-greenlight-energises-1-5-million-people-with-solar-kits/>

Tang, X., Liu, K., Wang, X., Gao, F., MacRo, J., & Widanage, W. D. (2020). Model Migration Neural Network for Predicting Battery Aging Trajectories. *IEEE Transactions on Transportation Electrification*, 6(2), 363–374. <https://doi.org/10.1109/TTE.2020.2979547>

The World Bank. (2021). *Report: Universal access to sustainable energy will remain elusive without addressing inequalities*. World Bank Group. <https://www.worldbank.org/en/news/press-release/2021/06/07/report-universal-access-to-sustainable-energy-will-remain-elusive-without-addressing-inequalities>

UN. (2017). Energy - United Nations Sustainable Development. In *Un*. <https://www.un.org/sustainabledevelopment/energy/>

UN. (2019). *Growing at a slower pace, world population is expected to reach 9.7 billion in 2050 and could peak at nearly 11 billion around 2100 | UN DESA | United Nations Department of Economic and Social Affairs*. Growing at a Slower Pace, World Population Is Expected to Reach 9.7 Billion in 2050 and Could Peak at Nearly 11 Billion around 2100. <https://www.un.org/development/desa/en/news/population/world-population-prospects-2019.html>

Vamsee, K. T., Kumar, M, M., & Kumar, P. C. (2020). Integrated Design and Control of Renewable Energy Sources for Energy Management. *Engineering Technology & Applied Science Research*, 10(3), 5857–5863. www.etasr.com

Wortmann, F., & Flüchter, K. (2015). Internet of Things: Technology and Value Added. *Business and Information Systems Engineering*, 57(3), 221–224. <https://doi.org/10.1007/s12599-015->

0383-3

Yi, Z., Dong, W., & Etemadi, A. H. (2018). A unified control and power management scheme for PV-Battery-based hybrid microgrids for both grid-connected and islanded modes. *IEEE Transactions on Smart Grid*, 9(6), 5975–5985. <https://doi.org/10.1109/TSG.2017.2700332>

APPENDICES

Appendix 1: Interview guide

Battery voltage level monitoring system in towers: A Case study HABARI NODE PUBLIC LIMITED COMPANY

The purpose of this study is to gain skills on existing manually way of monitoring voltage of battery in towers with its impact to Habari node plc. Benefits of this study is to provide **a battery voltage level monitoring system in tower through a dashboard** that will assist you to monitor the voltage of battery installed in your tower in real time, remotely and effectively. The aim of this face-to-face interview is to find out all challenges the company face during monitoring battery voltage fluctuation manually in towers. The gathered information will be considered in developing “Battery voltage level monitoring system”.

You have been considered as a potential key participant in this face-to-face interview because of your role and experience in this work. You are invited to participate in this interview which should only take about one hour of your time. Your answers will be kept confidential in a secured database and only be used for academic purpose. The participation of this interview is voluntary.

Unit A: Opening Questions

1. Would you mind if we can conduct this interview in your office or you have an idea of another place which is more comfortable?

.....

2. Can I know little about yourself and what is the name of your department”?

.....

3. How long have you been working in this company?

.....

4. Do you have any questions for me before we continue with our interview?

Unit B: introductory questions

5. How is your experience of working in this department?

.....

6. What are the processes of monitoring voltage level of battery installed in towers?

7. How many towers the company has around Arusha? And how many towers that present to have high voltage fluctuations? And what do you think is the cause?

8. What kind of tools do you use to monitor battery voltage?

9. How do you know that the voltage level of battery is low currently?

Unit C: Key Questions

10. How do you communicate on swapping the low battery? I mean for people to recharge low battery because it seems that your towers are not close to your office.

11. What are the challenges caused by the manual way you are using currently?

12. How do you try to overcome these challenges?

Unit D: Concluding Questions

13. Do you think the proposed battery voltage level monitoring system can be used in your company?

14. What would be the benefits of using proposed battery voltage level monitoring system in your company?

15. Are there any important items that we missed in our discussion today?

THANK YOU SO MUCH FOR YOUR VALUABLE TIME!

Appendix 2: Sample questions for user acceptance validation

Validation Features	Respondents			
	Strong Disagree	Disagree	Agree	Strong Agree
1.The Developed system accomplish the requirements for improving access to battery usage in the towers				
2. The Dashboard Android application is reliable to information access that we will need				
3. The user interface for The Android application for this system is interactive				
4.The developed system will improve Habari node productivity				
5. Android application will improve access to battery installed in the towers online and will improve data visualization				
6. Will you be interested to proceed using the system.				

Appendix 3: User testing

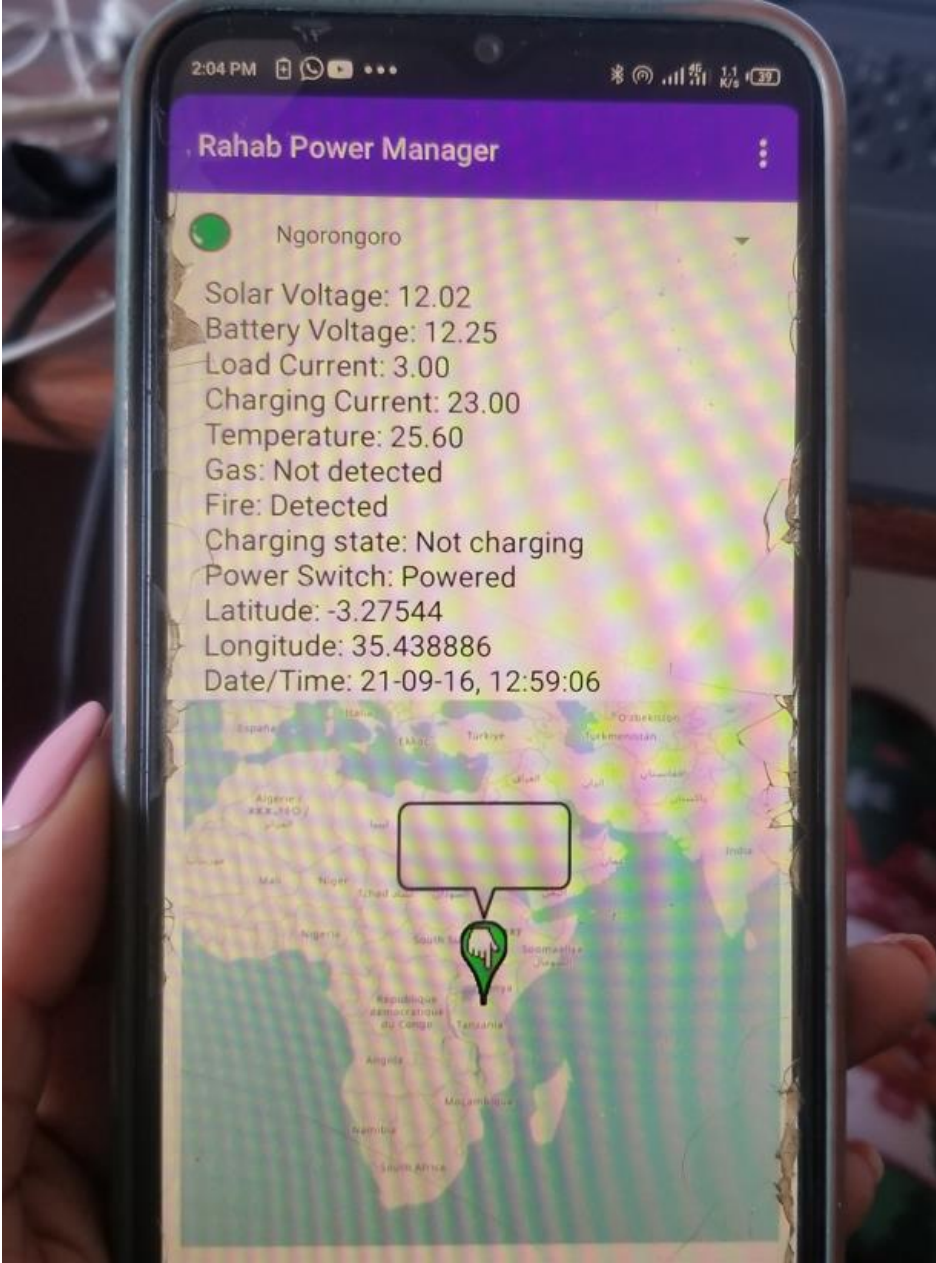

Appendix 4: Program source code for NGORONGORO Tower

```
String inputString = "";
double solar_volt,volt_battery,load_current,charging_current,ambient_temp1,ambient_temp2;
char flame flag='0', charging='0', Hydrogen gas='0',power_out='1';
#include "DHT.h"
#define DHTPIN 2
#define DHTTYPE DHT11 // DHT 11
DHT dht (DHTPIN, DHTTYPE);
void setup() {
dht.begin();
pinMode(6, OUTPUT);
pinMode (5, OUTPUT);
pinMode (10, OUTPUT);
pinMode (11, OUTPUT);
pinMode (12, OUTPUT);
pinMode (13, OUTPUT);
pinMode (2, INPUT);
pinMode (A5, INPUT);
pinMode (A4, INPUT);
pinMode (A0, INPUT);
pinMode (A1, INPUT);
pinMode (A2, INPUT);
pinMode (A3, INPUT);
digitalWrite(5, HIGH);
digitalWrite (6, HIGH);
Serial.begin(9600);
delay(3000);
start_WAN_TCP_client();
disconnect_device_at_server();
register_device_at_server();
//requestDateAndTime ();
delay (3000);
}void loop() {
// put your main code here, to run repeatedly:
get_readings_from_sensors();
//time_and_date_query();
send_data_to_server();
delay(800);
SendMessage11();
}void serialEvent() {
while (Serial.available()) {
char inChar = (char)Serial.read();
inputString += inChar;
if (inChar == '\n') {
```

```

if(inputString=="CTRL|0|~\r\n"){
digitalWrite(6, LOW);
power_out = '0';
} else if(inputString=="CTRL|1|~\r\n") {
digitalWrite(6, HIGH);
power_out = '1';
} inputString = "";}}}
void send_data_to_server () {
Serial.print("AT+CIPSEND\r\n");delay(2000);
Serial.print("/WFTF|Ngorongoro|Ngorongoro|DATA|");
Serial.print(solar_volt);
Serial.write('#');//***** volt_Battery ***
Serial.print(volt_battery);
Serial.write('#');//***** load_current ***
Serial.print(load_current);
Serial.write('#');//***** charging_current ***
Serial.print(charging_current);
Serial.write('#');//***** Hydrogen_gas ***
Serial.write(Hydrogen_gas)
Serial.write('#');//***** fire ***
Serial.write(flame_flag);
Serial.write('#');//***** ambient_temp ***
Serial.print(ambient_temp1);
Serial.write('#');//***** charging flag ***
Serial.write(charging);
Serial.write('#');//***** power flag ***
Serial.write(power_out);
Serial.write('#');//***** Lattitude ***
Serial.print("-3.27544");
Serial.write('#');//***** Longitude ***
Serial.print("35.438886");
Serial.write('#');
Serial.print("21-09-16, 12:06:06");
Serial.write('#');
Serial.print("|RahabSPM_1234|Rahab_SPM|Clusters|RAHAB|DATA|*|~\r\n");
Serial.write(0x1A); _delay_ms(1000);}
void get_readings_from_sensors(){
double ADC_value;
ADC_value = analogRead(A0);
solar_volt = ADC_value * 0.02499989;
float average1=0;
for (int i=0;i<1000;i++){ADC_value = analogRead(A0);
solar_volt = ADC_value * 0.02499989; average1=average1+(solar_volt)/1000;
delayMicroseconds(20);}solar_volt =average1;average1=0; ADC_value =
analogRead(A1);ADC_value= ((ADC_value * 5) / 1024.0) ; charging_current =((ADC_value-

```

```

2.4838856)/0.1);charging_current= abs(charging_current-0.0999); average1=0; for(int
i=0;i<1000;i++) { ADC_value = analogRead(A1);
ADC_value= ((ADC_value * 5) / 1024.0) ;
charging_current =((ADC_value-2.4838856)/0.1); charging_current= abs(charging_current-
0.0999); average1=average1+(charging_current)/1000;
delayMicroseconds (20);} average1=abs(average1-0.11); charging_current=average1;
average1=0; ADC_value = analogRead(A2); ADC_value= (ADC_value / 1024.0) * 5;
load_current = ((ADC_value-2.4838856)/0.1); load_current= abs(load_current-0.0999);
average1=0; for(int i=0;i<1000;i++) { ADC_value = analogRead(A2); ADC_value= (
ADC_value / 1024.0) * 5; load_current = ((ADC_value-2.4838856)/0.1); load_current=
abs(load_current-0.0999); average1=average1+(load_current)/1000;delayMicroseconds(20);}
average1=abs(average1-0.15); load_current=average1; average1=0; ADC_value =
analogRead(A3); volt_battery =ADC_value * 0.0249999;
average1=0; for(int i=0;i<1000;i++)
{ADC_value = analogRead(A3);
volt_battery =ADC_value * 0.0249999;
average1=average1+(volt_battery)/1000;
delayMicroseconds (20);
}volt_battery=average1;
average1=0; if(charging_current>=0.8){
charging = '1';
digitalWrite(11, HIGH);
}else{ charging = '0';
digitalWrite(11, LOW);
} if(analogRead(A5) <= 200){ //no gas detected
Hydrogen_gas = '0';}else { //gas detected
Hydrogen_gas = '1';
} if(analogRead(A4) >=990){ //no flame detected
flame_flag = '0'; }else { //flame detected
flame_flag = '1';} if((Hydrogen_gas == '1')|(flame_flag == '1')){
digitalWrite (10, HIGH); }else{ digitalWrite(10, LOW); }read_DHT11();
}void read_DHT11(){ float t = dht.readTemperature();
ambient_temp1 = t; }void disconnect_device_at_server(){
Serial.print("AT+CIPSEND\r\n");
delay(2000); Serial.print("/DISCONNECT|RahabSPM_1234|Rahab_SPM|Ngorongoro|~\r\n");
Serial.print(0x1A); delay(1000);}
void register_device_at_server(){
Serial.print("AT+CIPSEND\r\n"); delay(2000);
Serial.print("/CONNECT|RahabSPM_1234|Rahab_SPM|Ngorongoro|3|*|~\r\n");
Serial.write(0x1A); delay(1000);
}void start_WAN_TCP_client(){
Serial.print("AT\r\n"); delay(500);
Serial.print("AT+CMGF=1\r\n"); delay (500);
Serial.print("AT\r\n"); delay (500);
Serial.print("AT+CIPSHUT\r\n");

```

```

delay (500); Serial.print("AT+CIPMUX=0\r\n");
delay (500); Serial.print("AT+CGATT=1\r\n");
delay (500); Serial.print("AT+CSTT=");
Serial.write(""); Serial.print("internet");
Serial.write(""); Serial.write(',');
Serial.write("");
Serial.write("");
Serial.write(',');
Serial.write("");
Serial.write("");
Serial.print("\r\n");
delay (500);
Serial.print("AT+CIICR\r\n");
delay (2000);
Serial.print("AT+CIFSR\r\n");
delay (500); // _delay_ms(2000);
Serial.print("AT+CIPSTART=");
Serial.write("");
Serial.print("TCP");
Serial.write("");
Serial.write(',');
Serial.write("");
Serial.print("18.185.72.169"); //ip address
Serial.write("");
Serial.write(',');
Serial.print("8259\r\n");
}void requestDateAndTime (){
Serial.print("AT+CIPSEND\r\n");
delay(2000);
Serial.print("/RDT|Ngorongoro|RahabSPM_1234|Rahab_SPM|~\r\n");
Serial.write(0x1A); delay(2000);
}void time_and_date_query(){
Serial.print("AT\r\n");//GPRS_USART_send_string("Ju\r\n");
delay (500) ;//wait_for_response ();
Serial.print("AT+CCLK?\r\n");
delay(2000);
}void SendMessage11()
{if(volt_battery<=11.7){
Serial.println("AT+CMGF=1");
delay(200); // Delay of 1000 milli seconds or 1 second
Serial.println("AT+CMGS="+255685366686"\r\n");
delay (300); Serial.println(" WARNING!!! ");//
Serial.println(" Ngorongoro battery voltage level is low");
delay(200); Serial.println((char)26);// ASCII code of CTRL+Z
delay (400);}}

```

Appendix 5: Prototype development stage

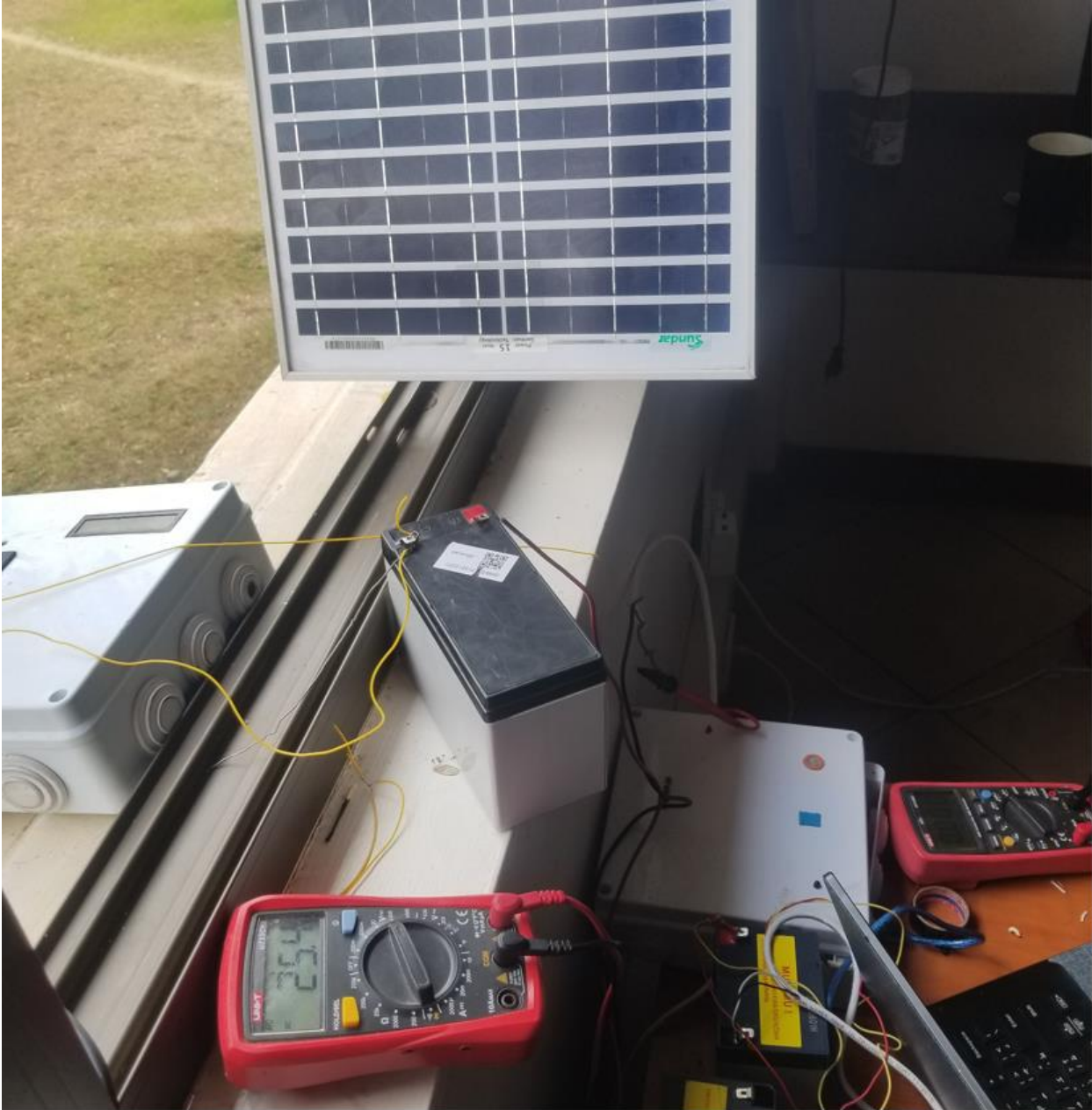

Appendix 6: Program source code for MANYARA Tower

```
start_WAN_TCP_client();
disconnect_device_at_server();
register_device_at_server();
//requestDateAndTime ();
delay (3000);
}void loop() {
// put your main code here, to run repeatedly:
get_readings_from_sensors();
//time_and_date_query();
send_data_to_server();
delay(800);
SendMessage11();
}void serialEvent() {
while (Serial.available()) {
char inChar = (char)Serial.read();
inputString += inChar;
if (inChar == '\n') {
if(inputString=="CTRL|0|~\r\n"){
digitalWrite (6, LOW);
power_out = '0';
} else if(inputString=="CTRL|1|~\r\n") {
digitalWrite (6, HIGH); power_out = '1';
} inputString = "";}} void send_data_to_server () {
Serial.print("AT+CIPSEND\r\n"); delay(2000);
Serial.print("/WFTF|Manyara|Manyara|DATA|");
Serial.print(solar_volt);
Serial.write('#');//***** volt_Battery ***
Serial.print(volt_battery);
Serial.write('#');//***** load_current ***
Serial.print(load_current);
Serial.write('#');//***** charging_current ***
Serial.print(charging_current);
Serial.write('#') ;//***** Hydrogen_gas ***
Serial.write(Hydrogen_gas)
Serial.write('#');//***** fire ***
Serial.write(flame_flag);
Serial.write('#');//***** ambient_temp ***
Serial.print(ambient_temp1);
Serial.write('#');//***** charging flag ***
Serial.write(charging);
Serial.write('#') ;//***** power flag ***
Serial.write(power_out);
Serial.write('#') ;//***** Lattitude ***
```



```

Serial.print("-3.27544");
Serial.write('#') ;//***** Longitude ***
Serial.print("35.438886");
Serial.write('#');
Serial.print("21-09-16, 12:06:06");
Serial.write('#');
Serial.print("|RahabSPM_1234|Rahab_SPM|Clusters|RAHAB|DATA|*|~|\r\n");
Serial.write(0x1A); _delay_ms (1000);}
void get_readings_from_sensors () {
double ADC_value;
ADC_value = analogRead(A0);
solar_volt = ADC_value * 0.02499989;
float average1=0;
for (int i=0; i<1000; i++) {ADC_value = analogRead(A0);
solar_volt = ADC_value * 0.02499989; average1=average1+(solar_volt)/1000;
delayMicroseconds (20);} solar_volt =average1; average1=0; ADC_value = analogRead(A1);
ADC_value= ((ADC_value * 5) / 1024.0); charging_current =((ADC_value-2.4838856)/0.1);
charging_current= abs(charging_current-0.0999); average1=0; for (int i=0; i<1000; i++)
{ADC_value = analogRead(A1);
ADC_value= ((ADC_value * 5) / 1024.0);
charging_current =((ADC_value-2.4838856)/0.1); charging_current= abs(charging_current-
0.0999); average1=average1+(charging_current)/1000;
delayMicroseconds (20);} average1=abs(average1-0.11); charging_current=average1;
average1=0; ADC_value = analogRead(A2); ADC_value= (ADC_value / 1024.0) * 5;
load_current = ((ADC_value-2.4838856)/0.1); load_current= abs(load_current-0.0999);
average1=0; for (int i=0; i<1000; i++) {ADC_value = analogRead(A2); ADC_value=
(ADC_value / 1024.0) * 5; load_current = ((ADC_value-2.4838856)/0.1); load_current=
abs(load_current-0.0999); average1=average1+(load_current)/1000; delayMicroseconds (20);}
average1=abs(average1-0.15); load_current=average1; average1=0; ADC_value =
analogRead(A3); volt_battery =ADC_value * 0.0249999;
average1=0; for (int i=0; i<1000; i++)
{ADC_value = analogRead(A3);
volt_battery =ADC_value * 0.0249999;
average1=average1+(volt_battery)/1000;
delayMicroseconds (20);
} volt_battery=average1;
average1=0; if(charging_current>=0.8) {
charging = '1';
digitalWrite (11, HIGH);
} else {charging = '0';
digitalWrite (11, LOW);
} if(analogRead(A5) <= 200) {//no gas detected
Hydrogen_gas = '0';} else {//gas detected
Hydrogen_gas = '1';
} if(analogRead(A4) >=990) {//no flame detected

```

```

flame_flag = '0';} else { //flame detected
flame_flag = '1';} if ((Hydrogen_gas == '1') | (flame_flag == '1')) {
digitalWrite (10, HIGH);} else {digitalWrite (10, LOW);} read_DHT11();
} void read_DHT11() {float t = dht. read Temperature ();
ambient_temp1 = t;} void disconnect_device_at_server () {
Serial.print("AT+CIPSEND\r\n");
delay (2000); Serial.print("/DISCONNECT|RahabSPM_1234|Rahab_SPM|Manyara|~\r\n");
Serial.print(0x1A); delay (1000);}
void register_device_at_server () {
Serial.print("AT+CIPSEND\r\n"); delay (2000);
Serial.print("/CONNECT|RahabSPM_1234|Rahab_SPM|Manyara|3|*|~\r\n");
Serial.write(0x1A); delay (1000);
} void start_WAN_TCP_client () {
Serial.print("AT\r\n"); delay (500);
Serial.print("AT+CMGF=1\r\n"); delay (500);
Serial.print("AT\r\n"); delay (500);
Serial.print("AT+CIPSHUT\r\n");
delay (500); Serial.print("AT+CIPMUX=0\r\n");
delay (500); Serial.print("AT+CGATT=1\r\n");
delay (500); Serial.print("AT+CSTT=");
Serial.write(""); Serial.print("internet");
Serial.write(""); Serial.write(',');
Serial.write("");
Serial.write("");
Serial.write(',');
Serial.write("");
Serial.write("");
Serial.write("");
Serial.print("\r\n");
delay (500);
Serial.print("AT+CIICR\r\n");
delay (2000);
Serial.print("AT+CIFSR\r\n");
delay (500); // _delay_ms (2000);
Serial.print("AT+CIPSTART=");
Serial.write("");
Serial.print("TCP");
Serial.write("");
Serial.write(',');
Serial.write("");
Serial.print("18.185.72.169"); //ip address
Serial.write("");
Serial.write(',');
Serial.print("8259\r\n");
} void requestDateAndTime () {
Serial.print("AT+CIPSEND\r\n");

```

```

delay (2000);
Serial.print("/RDT|Manyara|RahabSPM_1234|Rahab_SPM|~\r\n");
Serial.write(0x1A); delay (2000);
} void time_and_date_query () {
Serial.print("AT\r\n") ;//GPRS_USART_send_string("Ju\r");
delay (500) ;//wait_for_response ();
Serial.print("AT+CCLK? \r\n");
delay (2000);
} void SendMessage11()
{if(volt_battery<=11.7) {
Serial.println("AT+CMGF=1");
delay (200); // Delay of 1000 milli seconds or 1 second
Serial.println("AT+CMGS="+255685366686"\r");
delay (300); Serial.println(" WARNING!!! ");//
Serial.println(" Manyara battery voltage level is low");
delay (200); Serial.println((char)26) ;// ASCII code of CTRL+Z

delay (400);}}

```

Appendix 7: Program source code for Mobile dashboard (Rahab power Manager)

```
package com.example. rahabpowermanager;
import androidx.appcompat.app.ActionBar;
import androidx.appcompat.app.AppCompatActivity;
import android.app.AlertDialog;
import android.content.Context;
import android.content.Intent;
import android.content.SharedPreferences;
import android.graphics.Color;
import android.os.Bundle;
import android.os.Handler;
import android.preference.PreferenceManager;
import android.view.Menu;
import android.view.MenuInflater;
import android.view.MenuItem;
import android.view.View;
import android.widget.AdapterView;
import android.widget.AdapterView.OnItemClickListener;
import android.widget.ArrayAdapter;
import android.widget.Button;
import android.widget.ImageView;
import android.widget.Spinner;
import android.widget.TextView;
import android.widget.Toast;

import org.osmdroid.api.IMapController;
import org.osmdroid.tileprovider.tilesource.TileSourceFactory;
import org.osmdroid.util.GeoPoint;
import org.osmdroid.views.MapView;
import org.osmdroid.views.overlay.Marker;
import java.io.File;
import java.io.FileInputStream;
import java.io.FileOutputStream;
import java.io.IOException;
import java.io.InputStream;
import java.io.OutputStream;
import java.lang.reflect.Array;
import java.net.Socket;
import java.net.SocketException;
import java.text.SimpleDateFormat;
import java.util.ArrayList;
import java.util.Calendar;
import java.util.List;
public class MainActivity extends AppCompatActivity {
StringstrIPAddress"18.185.72.169",strPortNumber="8259",TCPSendData,TCPReadData,strDevi
ceID;TextView tvText; Button btnPower;
```

```

Spinner spnLocation;
ImageView imgConnectionStatus;
MapView map = null;
IMapController mapController;
Boolean blnPowerState=false,blnConnected=false; final Context mContext = this;
private Socket TcpSocket;
private boolean connectOk = false;
private tcpReadThread mtcpReadThread;
private String remoteAddress;
private String localAddress;
private final Handler tcpHandler = new C03553();
File dirTankPageInfo,dirOfficeDetails;
final Runnable updater = new Runnable(){public void run(){TCPSendTimer();
mHandler.postDelayed(this, 5000); //ms interval}};final Handler mHandler = new
Handler();protected void onCreate(Bundle savedInstanceState) {
super.onCreate(savedInstanceState); try {
Contextctx = getApplicationContext();org.osmdroid.config.Configuration.getInstance().load(ctx,
PreferenceManager.getDefaultSharedPreferences(ctx)); }catch(Exception
e){}setContentView(R.layout.activity_main); map = (MapView) findViewById(R.id.map);
map.setTileSource(TileSourceFactory.MAPNIK);imgConnectionStatus =
(ImageView)findViewById(R.id.ivConnectionStatus);
spnLocation = (Spinner)findViewById(R.id.spnLocation);
tvText = (TextView)findViewById(R.id.tvText);
btnPower = (Button)findViewById(R.id.btnPower);
map = (MapView)findViewById(R.id.map);ActionBar actionBar;
actionBar = getSupportActionBar(); if(actionBar != null){
actionBar.setHomeButtonEnabled(true);actionBar.setDisplayHomeAsUpEnabled(true)}map.setB
uiltInZoomControls(true);
map.setMultiTouchControls(true); mapController = map.getController();
btnPower.setOnClickListener(new View.OnClickListener() { public void onClick(View v) {
if (!connectOk) return; if(blPowerState){ blnPowerState = false;
TCPSend("/CTRL|RahabSPM_Admin|" + strDeviceID +
"|0|RahabSPM_1234|Rahab_SPM|*|~\r\n");
btnPower.setText("ON"); Toast.makeText(MainActivity.this, "Turned off",
Toast.LENGTH_SHORT).show(); }else{ blnPowerState = true;
TCPSend("/CTRL|RahabSPM_Admin|" + strDeviceID +
"|1|RahabSPM_1234|Rahab_SPM|*|~\r\n");
btnPower.setText("OFF");
Toast.makeText(MainActivity.this, "Turned on", Toast.LENGTH_SHORT).show();
}
}
});
List<String> categories1 = new ArrayList<String>();
categories1.add("Ngorongoro");
categories1.add("Manyara");

```

```

        categories1.add("Lokisale");
        ArrayAdapter<String> dataAdapter1 = new ArrayAdapter<String>(this,
android.R.layout.simple_spinner_item, categories1);
dataAdapter1.setDropDownViewResource(android.R.layout.simple_spinner_dropdown_item);
spnLocation.setAdapter(dataAdapter1);try {
    strDeviceID = InAppDataRead("spnLocation");
int    intIndex    =    Integer.parseInt(InAppDataRead("spnIndex"));
spnLocation.setSelection(intIndex);}catch    (Exception
e){spnLocation.setSelection(0);strDeviceID = "Ngorongoro";}
spnLocation.setOnItemClickListener(new AdapterView.OnItemClickListener() {
    @Override public void onItemClick(AdapterView<?> parent, View view, int position, long
id) {
        if(!connectOk) return;

        strDeviceID = spnLocation.getSelectedItem().toString();
        InAppDataSave("spnLocation", strDeviceID);
        InAppDataSave("spnIndex", String.valueOf(position));
    }

    @Override
    public void onNothingSelected(AdapterView<?> parent) {}
});
}
@Override
public boolean onCreateOptionsMenu(Menu menu) {
    MenuInflater inflater = getMenuInflater();
    inflater.inflate(R.menu.my_options_menu, menu);
    return true; } @Override
public boolean onOptionsItemSelected(MenuItem item) {
    //respond to menu item selection
    switch (item.getItemId()) {
        case R.id.Start:
            //send TCP connection details
            try{
                new C03531().start();
                //tvPumpAction.setText("IP: " + strIPAddress);
                //tvMinimumLevel.setText("Port: " + strPortNumber);
                //TCPSend("/CONNECT1|" + strUsername + "\nCompany Name: " + strUsername +
"\nCompany Address: " + strCompanyAddress + "\nCompany Email: " + strUserEmail +
"\nCompany Password: " + strUserPassword + "|"); //Connect to server

            }catch (Exception e) {
                //MsgBox("No internet connection. Ensure that internet is available to this computer
Or error establishing connection server.")
                // e.printStackTrace();
            }
        }
    }
}

```

```

        Toast.makeText(MainActivity.this, "No internet connection. Ensure that internet is\n
available to this computer Or error establisng\n connection server.",
Toast.LENGTH_SHORT).show();
    }
    return true;
case R.id.Stop:
    //send TCP disconnection details
    if (connectOk) {
        disconnect();
        //messegeDisplay("Disconnect", remoteAddress);
        //return;
    }
    return true;
case R.id.About:
    AlertDialogDisplay("About","This app helps monitor battery voltage level in Towers.
Case study, HABARI NODE PLC." +
        "\nPresented by: Rahab UWAMAHORO \nSupervisor: Dr. Neema and Dr. Dina
\nDepartment: EMOS \nSchool: COCSE, Mandela University." + "\n\n" +
        "Version: v.1.0.0.\n");
    return true;
case R.id.Exit:
    finish();
    return true;
//default:
}
return super.onOptionsItemSelected(item);
}

private void AlertDialogDisplay(String strTitle, String strContent){
    AlertDialog.Builder alertDialogBuilder = new AlertDialog.Builder(this);
    alertDialogBuilder.setMessage(strContent);
    alertDialogBuilder.setIcon(R.mipmap.ic_launcher_round);
    alertDialogBuilder.setTitle(strTitle);
    AlertDialog alertDialog = alertDialogBuilder.create();
    alertDialog.show();
}

class C03531 extends Thread {
    C03531() {
    }

    public void run() {
        connect();
    }
}

```

```

class C03542 extends Thread {
    C03542() {
    }

    public void run() {
        tcpWrite();
    }
}

class C03553 extends Handler {
    C03553() {
    }

    public void handleMessage(android.os.Message msg) {
        switch (msg.what) {
            case 1:
                try {
                    remoteAddress = TcpSocket.getRemoteSocketAddress().toString();
                    localAddress = TcpSocket.getLocalSocketAddress().toString();
                    mtcpReadThread = new tcpReadThread();
                    mtcpReadThread.start();
                    connectOk = true;
                    imgConnectionStatus.setImageResource(R.drawable.connected1);
                    Toast.makeText(MainActivity.this, "Connected!",
Toast.LENGTH_SHORT).show();
                    TCPSend("/CONNECT|RahabSPM_1234|Rahab_SPM|" + strDeviceID +
"|2*|~\r\n"); //Connect to server
                    return;
                } catch (NullPointerException e) {
                    e.printStackTrace();
                    return;
                }
            case 2:
                byte[] readBuf = (byte[]) msg.obj;
                String readMessage = null;
                try {
                    readMessage = new String(readBuf, 0, msg.arg1);
                } catch (StringIndexOutOfBoundsException e2) {
                    e2.printStackTrace();
                }
                if (readMessage != null) {
                    //messegeDisplay(readMessage, remoteAddress);
                    TCPReadData = readMessage;
                    TCPDataReceived();
                }
            }
        }
    }
}

```



```

        return;
    }
    return;
case 3:
    disconnect();
    Toast.makeText(MainActivity.this, "Disconnect", Toast.LENGTH_SHORT).show();
    //messegeDisplay("Disconnect", remoteAddress);
    return;
case 4:
    String sendMessag = msg.obj.toString();
    //Toast.makeText(MainActivity.this, sendMessag,
Toast.LENGTH_SHORT).show();
    //messegeDisplay(sendMessag, remoteAddress);
    return;
case 5:
    //messegeDisplay("", (String) msg.obj);
    Toast.makeText(MainActivity.this, "Can't Connect",
Toast.LENGTH_SHORT).show();
    return;
default:
    }
}
}

```

```

private class tcpReadThread extends Thread {
    private final InputStream tcpInStream;

    public tcpReadThread() {
        InputStream tmpIn = null;
        try {
            tmpIn = TcpSocket.getInputStream();
        } catch (IOException e) {
        }
        tcpInStream = tmpIn;
    }

    public void run() {
        super.run();
        byte[][] Rcv = (byte[][]) Array.newInstance(Byte.TYPE, new int[]{100, 4096});
        byte Index = (byte) 0;
        while (connectOk) {
            int readDataSize = 0;
            try {
                readDataSize = tcpInStream.read(Rcv[Index]);
            } catch (IOException e) {
            }
        }
    }
}

```

```

        e.printStackTrace();
    }
    if (readDataSize == -1) {
        connectOk = false;
        tcpHandler.obtainMessage(3).sendToTarget();
    } else if (readDataSize > 0) {
        tcpHandler.obtainMessage(2, readDataSize, -1, Rcv[Index]).sendToTarget();
        if (Index >= (byte) 99) {
            Index = (byte) 0;
        } else {
            Index = (byte) (Index + 1);
        }
    }
}
}
}

protected void onStart() {
    super.onStart();
}

/*private void messegeDisplay(String message, String address) {
    tvReceived.setText(message + ":" + address);
}*/

public void connect() {
    String ipAddress = null;
    try {
        ipAddress = strIPAddress;
        int port = Integer.parseInt(strPortNumber);
        TcpSocket = new Socket(ipAddress, port);
    } catch (SocketException e) {
        e.printStackTrace();
    } catch (IOException e2) {
        e2.printStackTrace();
    }
    if (TcpSocket == null) {
        tcpHandler.obtainMessage(5, ipAddress).sendToTarget();
    } else if (TcpSocket.isConnected()) {
        tcpHandler.obtainMessage(1).sendToTarget();
    } else {
        tcpHandler.obtainMessage(5, ipAddress).sendToTarget();
    }
}
}

```

```

private void tcpWrite() {
    String sendString = TCPSendData;
    byte[] sendByte = sendString.getBytes();
    try {
        TcpSocket.getOutputStream().write(sendByte);
        tcpHandler.obtainMessage(4, sendString).sendToTarget();
    } catch (IOException e) {
        e.printStackTrace();
    }
}

private void TCPSend(String strDataToSend){
    TCPSendData = strDataToSend;
    if (connectOk) {
        //if(strDeviceID!=null) {
            new C03542().start();
        /*}else{
            Toast.makeText(mContext, "No location selected", Toast.LENGTH_SHORT).show();
        }*/
    }
}

private void TCPDataReceived(){
    String[] strReceivedSection1 = TCPReadData.split("\\|");
    switch (strReceivedSection1[0]){
        case "/Connected":
            try{
                //imgConnectionStatus.setImageResource(R.drawable.connected1);
                blnConnected = true;
                mHandler.post(updater);
                //Toast.makeText(getApplicationContext(), "Yes, it's working.",
                Toast.LENGTH_LONG).show();

            } catch (Exception e) {
                //imgConnectionStatus.setImageResource(R.drawable.notconnected1);
                blnConnected = false;
                Toast.makeText(getApplicationContext(), "No network found, please connect to a
network and try again.", Toast.LENGTH_LONG).show();
                //e.printStackTrace();
            }
            break;
        case "/DISCONNECT":
            try{
                //imgConnectionStatus.setImageResource(R.drawable.notconnected1);
                blnConnected = false;

```

```

        mHandler.removeCallbacks(updater);
    } catch (Exception e) {
        //imgConnectionStatus.setImageResource(R.drawable.connected1);
        blnConnected = true;
        Toast.makeText(getApplicationContext(), "No network found, please connect to a
network and try again.", Toast.LENGTH_LONG).show();
        //e.printStackTrace();
    }
    break;
case "DATA":
    String[] strReceivedData = strReceivedSection1[1].split("\\#");

    switch (strReceivedData[4]){
        case "1":
            strReceivedData[4] = "Detected";
            break;
        case "0":
            strReceivedData[4] = "Not detected";
    }

    switch (strReceivedData[5]){
        case "1":
            strReceivedData[5] = "Detected";
            break;
        case "0":
            strReceivedData[5] = "Not detected";
    }

    switch (strReceivedData[7]){
        case "1":
            strReceivedData[7] = "Charging";
            break;
        case "0":
            strReceivedData[7] = "Not charging";
    }

    switch (strReceivedData[8]){
        case "1":
            strReceivedData[8] = "Powered";
            break;
        case "0":
            strReceivedData[8] = "Not powered";
    }
}

```

```

String formattedDate = new SimpleDateFormat("yyyy-MM-dd, hh:mm:ss
a").format(Calendar.getInstance().getTime());
strReceivedData[11] = formattedDate;

tvText.setText("Solar Voltage: " + strReceivedData[0] + "\nBattery Voltage: " +
strReceivedData[1] + "\nLoad Current: " + strReceivedData[2]
+ "\nCharging Current: " + strReceivedData[3] + "\nTemperature: " +
strReceivedData[6] + "°C\nGas: " + strReceivedData[4]
+ "\nFire: " + strReceivedData[5] + "\nCharging state: " + strReceivedData[7] +
"\nPower Switch: " + strReceivedData[8]
+ "\nLatitude: " + strReceivedData[9] + "\nLongitude: " + strReceivedData[10] +
"\nDate/Time: " + strReceivedData[11]);

//Show marker on map method
GeoPoint startPoint = new GeoPoint(Double.parseDouble(strReceivedData[9]),
Double.parseDouble(strReceivedData[10]));
Marker startMarker = new Marker(map);
startMarker.setPosition(startPoint);
startMarker.setAnchor(Marker.ANCHOR_CENTER, Marker.ANCHOR_BOTTOM);
map.getOverlays().add(startMarker);
mapController.setCenter(startPoint);
}
}

public void TCPSendTimer(){
//TCPSend("/SEND|" + strCompanyName + strCompanyID + "|"); //Send to server
TCPSend("/RQST|RahabSPM_Admin|" + strDeviceID +
"|RahabSPM_1234|Rahab_SPM|Clusters|Tanzania|DATA|~\r\n");
}

private void disconnect() {
/*try {
TCPSend("/DISCONNECT1|" + strUsername + "|~\r\n");
Toast.makeText(MainActivity.this, "Disconnected from Junics server",
Toast.LENGTH_SHORT).show();
}catch (Exception e){}*/
connectOk = false;
//imgConnectionStatus.setImageResource(R.drawable.notconnected1);
if (TcpSocket != null) {
try {
TcpSocket.close();
TcpSocket = null;
} catch (IOException e) {
e.printStackTrace();
}
}
}

```

```

    }
    //btnConnection.setText("Connect");
    //btnSend.setVisibility(View.INVISIBLE);
}

private void close() {
    disconnect();
}

protected void onResume() {
    super.onResume();
    //displaySharedPreferences();
}

protected void onStop() {
    super.onStop();
}

protected void onDestroy() {
    super.onDestroy();
    close();
    InAppDataSave("strIPAddress", strIPAddress);
    InAppDataSave("strPort", strPortNumber);
}

private String InAppDataRead(String strFileName) {
    String strRead = null;
    try {
        FileInputStream fin = openFileInput(strFileName);
        int c;
        String temp = "";
        while ((c = fin.read()) != -1) {
            temp = temp + Character.toString((char) c);
        }
        strRead = temp;
        //Toast.makeText(getBaseContext(),"RCV" + strFileName + "file read",
Toast.LENGTH_SHORT).show();
    } catch (Exception e) {
        //Toast.makeText(getBaseContext(), e.getMessage(), Toast.LENGTH_SHORT).show();
    }
    return strRead;
}

private void InAppDataSave(String strFileName, String strContent) {
    try {

```

```
        FileOutputStream fOut = openFileOutput(strFileName, MODE_WORLD_READABLE);
        fOut.write(strContent.getBytes());
        fOut.close();
        //Toast.makeText(getBaseContext(),"RCV" + strFileName + " file
saved",Toast.LENGTH_SHORT).show();
    } catch (Exception e) {
        // TODO Auto-generated catch block
        //e.printStackTrace();
    }
}
}
```

Appendix 8: Research output

Publication paper

R. Uwamahoro, N. Mduma, and D. Machuve, “A Battery Voltage Level Monitoring System for Telecommunication Towers”, *Engineering, Technology & Applied Science Research.*, vol. 11, no. 6, pp. 7875–7880, Dec. 2021. <https://www.etasr.com/index.php/ETASR/article/view/4550>

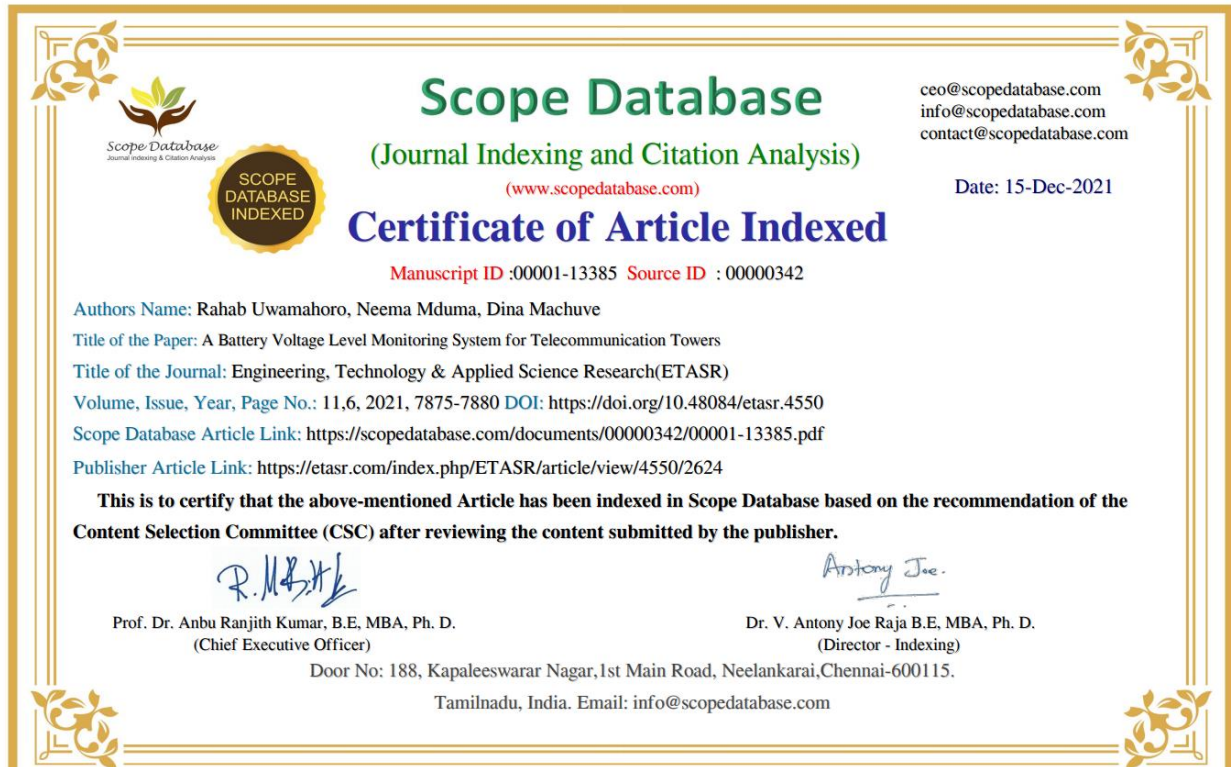

A Battery Voltage Level Monitoring System for Telecommunication Towers

Rahab Uwamahoro

School of Computational and Communication Sciences and Engineering
The Nelson Mandela African Institution of Science and Technology
Arusha, Tanzania

Neema Mduma

School of Computational and Communication Sciences and Engineering
The Nelson Mandela African Institution of Science and Technology
Arusha, Tanzania

Dina Machuve

School of Computational and Communication Sciences and Engineering
The Nelson Mandela African Institution of Science and Technology
Arusha, Tanzania

Abstract-Voltage fluctuations in batteries form a major challenge the telecommunication towers face. These fluctuations mostly occur due to poor management and the lack of a battery voltage level monitoring system. The current paper presents a battery voltage-level monitoring system to be used in telecommunication towers. The proposed solution is incorporated with a centralized mobile application dashboard for accessing the live data of the installed battery, integrated with voltage-level, current, temperature, fire, and gas sensors. An Arduino Uno microcontroller board is used to process and analyze the collected data from the sensors. The Global Service Message (GSM) module is used to monitor and store data to the cloud. Users are alerted in the case of low voltage, fire, and increase in harmful gases in the tower through Short Message Service (SMS). The experiment was conducted at Ngorongoro and Manyara telecommunication towers. The developed system can be used in accessing battery information remotely while allowing real-time continuous monitoring of battery usage. The proposed battery voltage-level monitoring system contributes to the elimination of battery hazards in towers. Therefore, the proposed battery voltage level monitoring system can be adopted by telecommunication tower engineers for the reduction of voltage fluctuation risks.

Keywords-battery voltage level monitoring; telecommunication towers; renewable energy; GSM sim 8001 module; dashboard

I. INTRODUCTION

Rapidly growing population, technological advancements, and climate change, raise the demand for more energy [1], which is expected to increase the Greenhouse Gas (GHG) emissions in the atmosphere. Global population, for instance, is expected to increase from 7.7 to 9 billion by 2050 [2], whereas, in Sub-Saharan Africa, where Tanzania is located, the population is predicted to double by 2050 [3]. Also, 80% of the 1.4 billion of the global population living in rural areas have inadequate access to electricity [4, 5]. These people not only

have a low life quality but also lack access to technology, which means that they fall under the energy poverty deception category. The instability of the national grid and the low proportion of the population accessing it, makes renewable energy a priority for electrification, especially in Africa, since it is low-cost, user-friendly, and can reduce carbon footprint [6]. Telecom tower companies in Tanzania have found significant reliable use of renewable energy by using solar panels to power their services during power outages and hence enabling a cost-efficient evolution to a low-carbon power system [7]. The advancements in solar energy are increasing in Tanzania [8]. However, solar energy offers efficient production only during the day. This necessitates energy storage in batteries to ensure the continuation of services [9-12].



Telecom towers connect people with their business remotely by accessing the internet and other services. Powering the towers requires a stable energy source for versatile operations. To guarantee their uninterrupted operation, the towers need to depend on renewable energy sources, like solar panels, to eliminate the inconveniences caused by unpredictable power cuts on the national grid [13, 14]. The most serious challenge encountered by telecom towers is the unexpected voltage drops followed by cutoffs that occur without alerting users to act accordingly. This makes the tower services unavailable, thus lowering productivity while putting sensitive electrical equipment at risk. Additionally, the hydrogen gas from batteries affects human health and the environment [15-17]. So, there is a need to monitor and eliminate battery voltage-level changes and other parameters that may pose a threat to public health and safety. Among the factors that have been identified as the primary contributors to voltage fluctuations are the lack of battery data visualization and the big number of devices allocated to be powered by a battery [18]. They, therefore, lack information with regard to when the voltage battery is expected to be low for timely actions. With the technological advancements through the

Corresponding author: Rahab Uwamahoro (uwamahoro@nm-aist.ac.tz)

www.etasr.com

Uwamahoro et al.: A Battery Voltage Level Monitoring System for Telecommunication Towers

Appendix 9: Poster publication



**A BATTERY VOLTAGE LEVEL MONITORING SYSTEM FOR TELECOMMUNICATION TOWERS
A CASE STUDY: HABARI NODE PUBLIC LIMITED COMPANY**

**Rahab Uwamahoro, Email: uwamahoror@nm-aist.ac.tz
Ncema Mduma, Email: ncema.mduma@nm-aist.ac.tz Dina Machuve, Email: dina.Machuve@nm-aist.ac.tz**

Introduction

Voltage fluctuations in batteries form a major challenge the telecommunication towers face. These fluctuations mostly occur due to poor management and the lack of a battery voltage level monitoring system. The current paper presents a battery voltage-level monitoring system to be used in telecommunication towers. The proposed solution is incorporated with a centralized mobile application dashboard for accessing the live data of the installed battery, integrated with voltage-level, current, temperature, fire, and gas sensors. An Arduino Uno microcontroller board is used to process and analyze the collected data from the sensors. The Global Service Message (GSM) module is used to monitor and store data to the cloud. Users are alerted in the case of low voltage, fire, and increase in harmful gases in the tower through Short Message Service (SMS). The experiment was conducted at Ngorongoro and Manyara telecommunication towers. The developed system can be used in accessing battery information remotely while allowing real-time continuous monitoring of battery usage. The proposed battery voltage-level monitoring system contributes to the elimination of battery hazards in towers. Therefore, the proposed battery voltage level monitoring system can be adopted by telecommunication tower engineers for the reduction of voltage fluctuation risks.

Problem statement

Battery users face challenges of power outages. This problem always happens without user alerts about when the voltage level is expected to be low for them to act accordingly by either swapping it or recharging it and other necessary information that can be used in risky situations. Power outages tend to cause data loss in companies and other places where batteries are installed, loss of time in physical visits, risks of damage to the powered electrical equipment, and environmental harms.

Objectives

General objective

The main objective of this project was to develop a battery voltage-level monitoring system in towers for the Habari Node Limited Company using a mobile dashboard for real-time access to batteries voltage level information.

Specific objectives

- i) To identify the requirements for developing
- ii) To design and develop the system
- iii) To validate the developed system.

Results

The experiments conducted in the field on the selected towers proved the status information from batteries located in the different towers: their voltage and current levels, temperatures, and presence of fire or gas could be monitored and risks of voltage fluctuation reduced. Figures 1 and 2 show that the voltage level and other parameters of battery status located at Ngorongoro tower were monitored using sensors and accessed through a mobile dashboard respectively. Data processed from the sensor were sent to the cloud in real-time as shown in Figures 1 and 2 for visualization of battery voltage level, current, temperature, early warning on fire if it presented, and gas status data through a mobile app dashboard.



Figure 1: System prototype

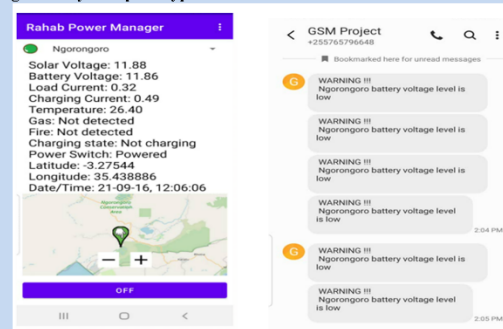

Figure2: Mobile dashboard